



Data center

Advanced power, safety and
grounding connections accessories

sicame



About us

sicame
GROUP

Sicame Group is one of the key players in the electrical equipment business worldwide. It has been able to adapt and develop to support the continuous evolution of electricity infrastructure in France and around the world, and become the largest independent entity in its sector.

A true player in the energy transition, it offers its customers new products and services to improve energy efficiency, deal with environmental risks and support the development of electric vehicle and solar power plant markets.

+65

years of worldwide success

525 M€

2022 turnover

3,600

employees

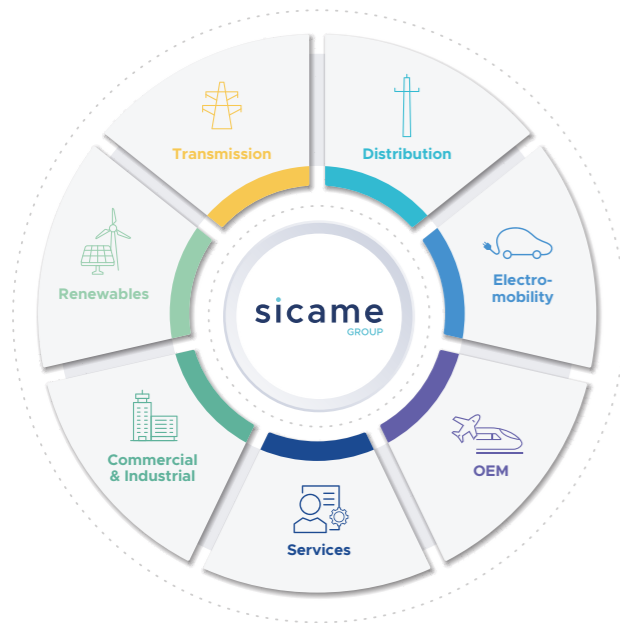

Our fields of activity

Sicame Group is specialised in **products and services** related to transmission and distribution of **electrical energy**, renewables, electromobility, safety equipment and industrial applications.

5 continents

26 countries

50 companies
around the world

Products distributed
in 157 countries



The Commercial and Industrial division of Sicame Group has been providing high-quality safety, earthing, tooling, cable accessory products for over 65 years and has become a trusted company in the electrical industry. Our skilled team of engineers and technicians are dedicated to developing innovative products that meet the highest safety standards and regulations. Our skilled team of engineers and technicians are dedicated to developing.

In a world where we all need information at the tip of our fingers, data centers are essential to our society and digital economy. Whatever happens online, whether it is companies' data or social medias, everything needs to be saved and housed in a data center. Being at the heart of our customers' needs and providing daily innovative and reliable solutions with the highest level of customer support and satisfaction, we had to be present within this extremely demanding and sensitive segment with reliable and trustworthy solutions.

Specificity of data center application

- Sensitive application
- High current in closed environment
- Flexible cable due to limited space
- Highly reliable connection needed



Flexible cable connection

Flexible cables are used to reduce the space needed to bend a cable where space is limited.



Risks linked to flexible cables

- Strands expand after insulation is stripped
- At same cross section: flexible cables occupy more space compared to rigid cable
- Insertion issue leads to use larger barrels
- ... and risk of bad crimp



Crimping expertise is essential

Standard hexagonal vs optimized B crimp comparison

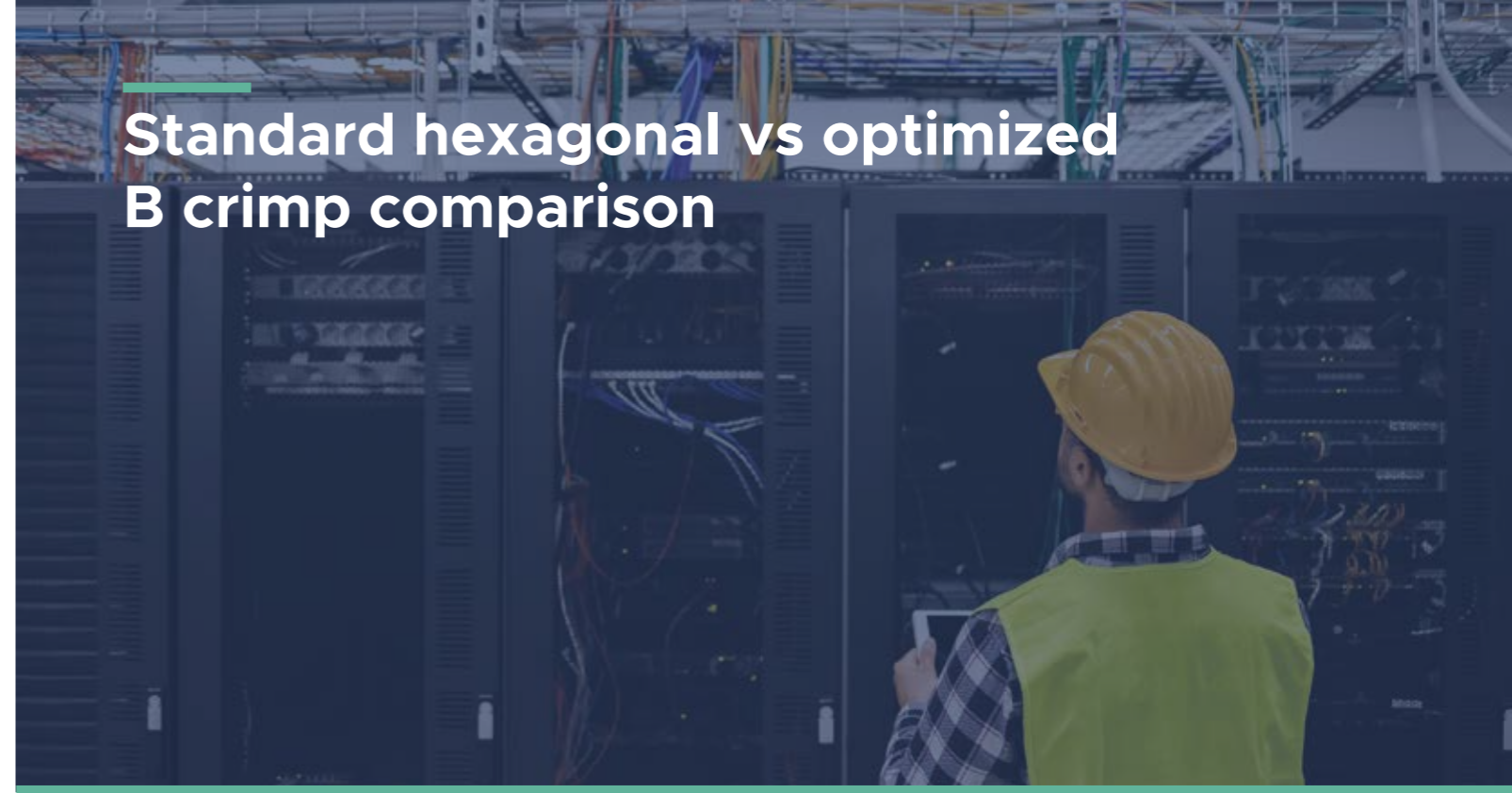

Poor contact between strands leads to high crimping resistance:

- High crimping resistance causes high temperature elevation
- Non optimized crimping may result in temperature reaching **170°C** instead of **110°C** with an optimized crimping

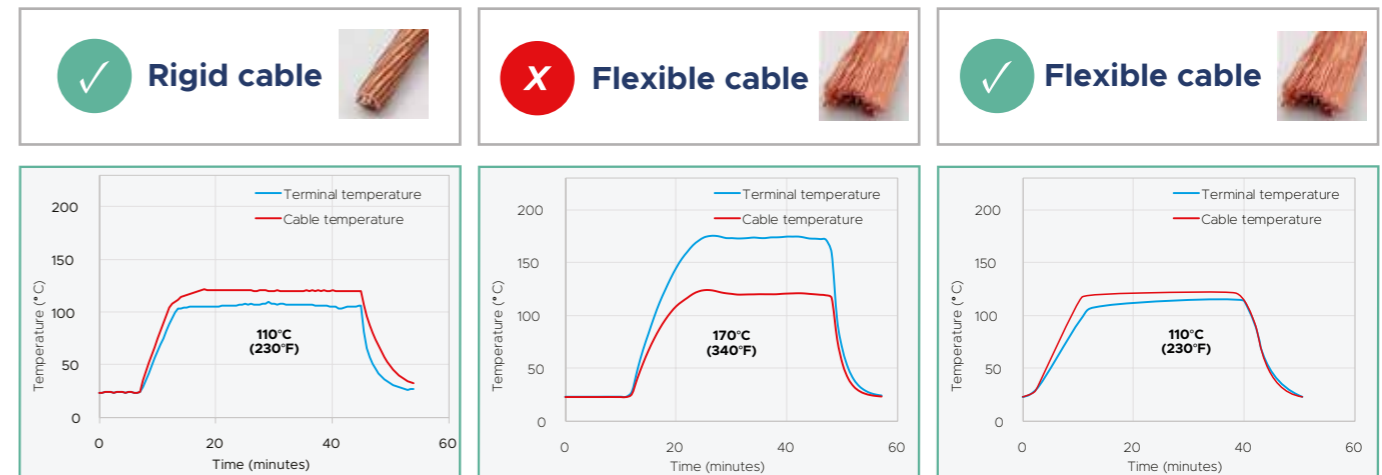

B crimp provides optimal performance with flexible cable

Compaction ratio analysis and performance optimization

- During crimping process, cable is compacted
- Compaction ratio (in%) is used as a development metric



B crimp compaction ratio (CR %)

- Compaction ratio is directly proportional to performance
- Trade-off between mechanical and electrical performance

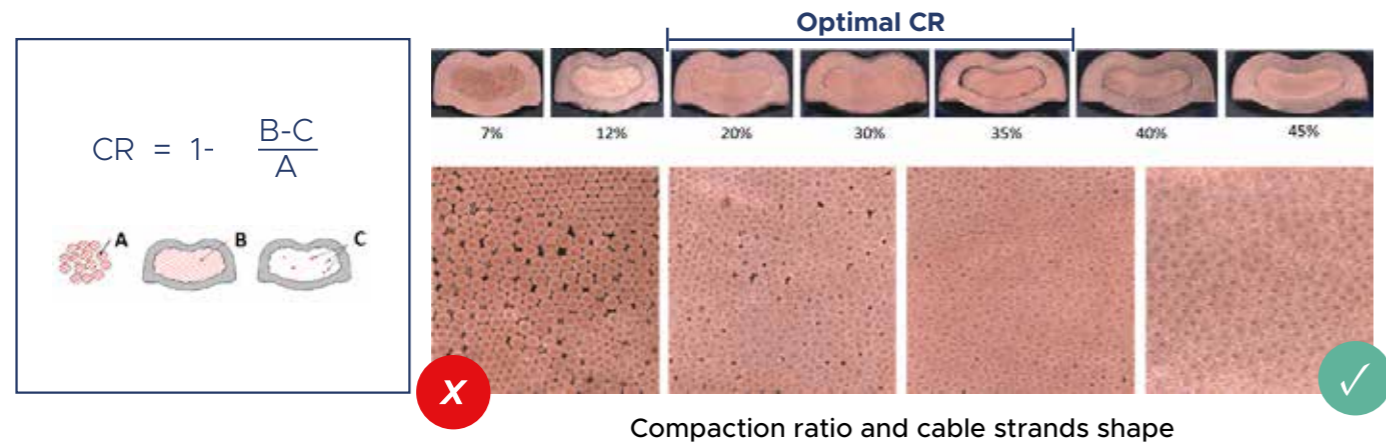

B shape crimping technology, optimized for flexible cable

Hexagonal shape

- Poor contact between strands
- High crimping resistance
- High temperature elevation
- Should only be used for rigid cable

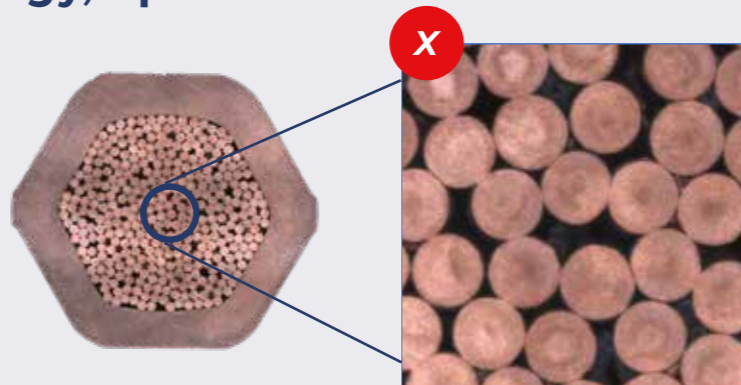

B crimp

- Optimized contact between strands
- Low crimping resistance
- Low temperature elevation
- OEM solution for flexible cable

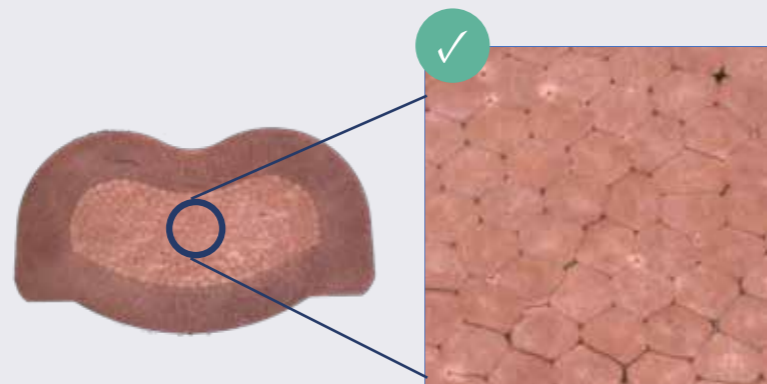

A reliable solution

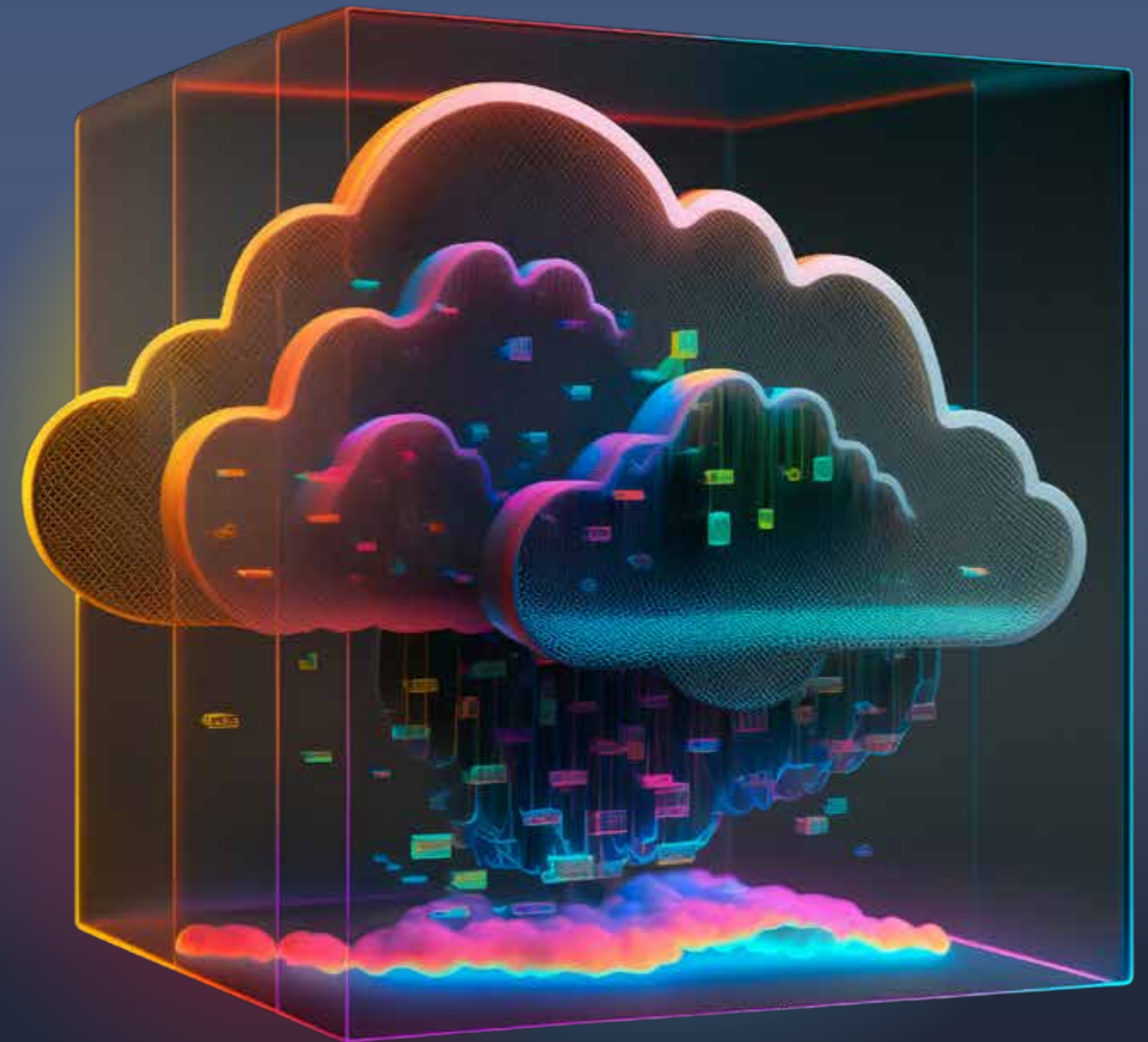

Tailor made solution

Mecatraction technical solution scope and validity:

- Lug and crimping tool are custom designed based on application cable
- Compaction ratio of the crimping is directly depending on the crimping configuration:
die + cable + terminal

System performance of the solution is granted by the specified combination cable/lug/die



Safety Instruction

Risk of connection failure

Never dissociate cable, lug and crimping tool.
Cable, lug and crimping tool are designed to work together for a given cable and section.





Laboratory test to verify connection performance

Laboratory tests – derating following EN 60512-5-2

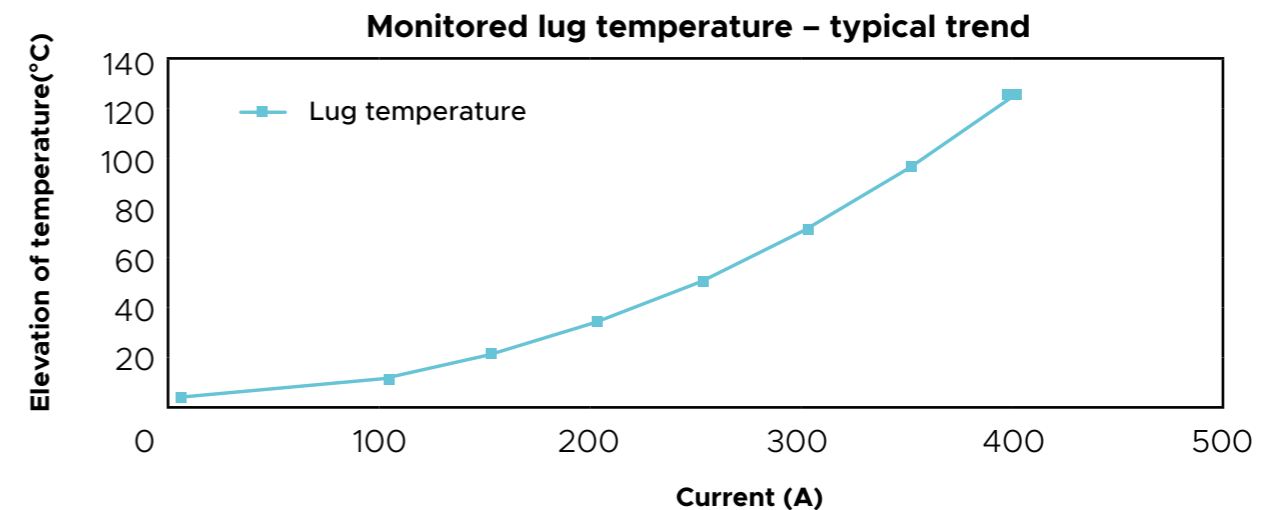
- International standard to assess maximum allowable current to ensure connection remains below its critical temperature
- Tests used in automotive, aeronautic, railway to ensure product will be sized to sustain current and temperature of the application



Lug temperature elevation under injected current

Wire section	DEF...T 1 Stud Holes	DEF...TSV 1 Stud Holes	Lug 2 Stud Holes	Ref die	Crimping tool	Ref die	Crimping tool	Electro-Hydraulic Group	
10	DEF10-5T DEF10-6T DEF10-8T DEF10-10T	DEF10-5TSV DEF10-6TSV DEF10-8TSV DEF10-10TSV DEF10-12TSV	DEF10-10-45	C12BDEF10		U21BDEF10		SPT21-585JCM for press SU210JCM and SH450JCM	
16	DEF16-5T DEF16-6T DEF16-8T DEF16-10T DEF16-12T	DEF16-5TSV DEF16-6TSV DEF16-8TSV DEF16-10TSV DEF16-12TSV	DEF16-6-15 DEF16-10-25 DEF16-10-45 DEF16-12-25 DEF16-12-45	C12BDEF16		U21BDEF16			
25	DEF25-6T DEF25-8T DEF25-10T	DEF25-5TSV DEF25-6TSV DEF25-8TSV DEF25-10TSV DEF25-12TSV	DEF25-8-25 DEF25-10-25 DEF25-10-45 DEF25-12-25 DEF25-12-45	C12BDEF25		U21BDEF25			U21B Die
35	DEF35-6T DEF35-8T DEF35-10T DEF35-12T	DEF35-6TSV DEF35-8TSV DEF35-10TSV DEF35-12TSV DEF35-14TSV	DEF35-10-25 DEF35-10-45 DEF35-12-25 DEF35-12-45 DEF35-14-45	C12BDEF35		U21BDEF35			U21B Die
50	DEF50-6T DEF50-8T DEF50-10T DEF50-12T	DEF50-6TSV DEF50-8TSV DEF50-10TSV DEF50-12TSV DEF50-14TSV	DEF50-10-25 DEF50-10-45 DEF50-12-25 DEF50-12-45 DEF50-14-45	C12BDEF50		U21BDEF50			U21B Die
70	DEF70-8T DEF70-10T	DEF70-6TSV DEF70-8TSV DEF70-10TSV DEF70-12TSV DEF70-14TSV DEF70-16TSV	DEF70-10-25 DEF70-10-45 DEF70-12-25 DEF70-12-45 DEF70-14-45	C12BDEF70 (2 step crimping)		U21BDEF70			U21B Die
95	DEF95-10T DEF95-12T	DEF95-8TSV DEF95-10TSV DEF95-12TSV DEF95-14TSV DEF95-16TSV	DEF95-8-25 DEF95-10-25 DEF95-10-40 DEF95-10-45 DEF95-12-25 DEF95-12-40 DEF95-12-45	C12BDEF95 (2 step crimping)		U21BDEF95			U21B Die
120	DEF120-8T DEF120-10T DEF120-12T DEF120-14T DEF120-16T DEF120-20T	DEF120-8TSV DEF120-10TSV DEF120-12TSV DEF120-14TSV DEF120-16TSV DEF120-20TSV	DEF120-10-25 DEF120-10-40 DEF120-10-45 DEF120-12-25 DEF120-12-40 DEF120-12-45 DEF120-12-50 DEF120-14-45 DEF120-14-50	C12BDEF120 (2 step crimping)		U21BDEF120			U21B Die

Wire section	DEF...T 1 Stud Holes	DEF...TSV 1 Stud Holes	Lug 2 Stud Holes	Ref die	Crimping tool	Ref die	Crimping tool	Electro-Hydraulic Group
150	DEF150-8T DEF150-10T DEF150-12T DEF150-14T DEF150-16T DEF150-20T	DEF150-8TSV DEF150-10TSV DEF150-12TSV DEF150-14TSV DEF150-16TSV DEF150-20TSV	DEF150-10-25 DEF150-12-25 DEF150-12-40 DEF150-12-45 DEF150-14-25 DEF150-14-40 DEF150-14-45	U21BDEF150 (2 step crimping)	U21B Die	H45BDEF150	U21B Die	SPT21-585JCM for press SU210JCM and SH450JCM
185	DEF185-10T DEF185-12T DEF185-14T DEF185-16T DEF185-20T	DEF185-10TSV DEF185-12TSV DEF185-14TSV DEF185-16TSV DEF185-20TSV	DEF185-10-25 DEF185-10-45 DEF185-12-25 DEF185-12-45 DEF185-14-25 DEF185-14-45	U21BDEF185 (2 step crimping)	U21B Die	H45BDEF185	U21B Die	
240	DEF240-12T DEF240-14T DEF240-16T DEF240-20T	DEF240-12TSV DEF240-14TSV DEF240-16TSV DEF240-20TSV	DEF240-10-45 DEF240-12-45	U21BDEF240 (2 step crimping)	U21B Die	H45BDEF240	U21B Die	
300	DEF300-12T DEF300-16T	DEF300-12TSV DEF300-14TSV DEF300-16TSV DEF300-20TSV	DEF300-10-25 DEF300-12-25 DEF300-12-45 DEF300-14-45	U21BDEF300 (2 step crimping)	U21B Die	H45BDEF300	U21B Die	
400			DEF400-10-25 DEF400-10-40 DEF400-10-45 DEF400-12-25 DEF400-12-40 DEF400-12-45 DEF400-14-40			H45BDEF400 (2 step crimping)	U21B Die	
500			DEF500-12-40 DEF500-14-40			H45BDEF500 (2 step crimping)	U21B Die	

Upon ordering the die, please specify the crimping tools that will be used to make sure they match each other.

DEF...T: With inspection hole
DEF...TSV: Without inspection hole
Other lug references on request

LV&MV underground networks power cable accessories

Sicame MV underground mastery

In 2005, Sicame acquired the medium voltage underground accessories business from Sagem Cables (also known as SILEC, now part of general cable). Along with an extensive portfolio of customers and products.

Since the 1970's, Sicame has built up and acquired a recognized know-how, offering a strong base of expertise for principles design, material formulations and data testing. Sicame has leveraged this experience into new dynamics through significant investments and a dedicated team.



Sicame has since vastly extended its product portfolio. Sicame is now proposing a complete range of accessories (joints, terminations, separable connectors) covering the main techniques of the industry (heat shrink, cold shrink, slip-on).

Based on Sicame product landmarks – reliability, ease of installation, adaptation - truly original accessory designs have been developed.

Products such as the All-In-One cold-shrink joint, 3-layer heat shrink body or “push-pull” (cold shrink patent) termination are now acclaimed as absolute best in class when it comes to quality and ease of installation.

Sicame also pioneered the mechanical connector evolution thanks to the first universal shear head patent.

"We are proud that our best in class product designs are backed up by jointers."



Sicame solutions for MV underground networks

The accessories from 6 to 36 kV include the following technologies

- Cold shrink
- Heat shrink
- Slip-on (push-on)
- Resin-injected or poured.
- Hybrid solutions (ex: cold shrink and resin-injected)

Included products

- Terminations (indoor, outdoor)
- Joints (1 core or 3 cores)
 - Straight through joints
 - Branch joints
 - Transitions
 - Dead ends
- Elbow connectors



MV overhead networks



LV overhead networks



MV underground networks



LV underground networks

Data center architecture

MV&LV application

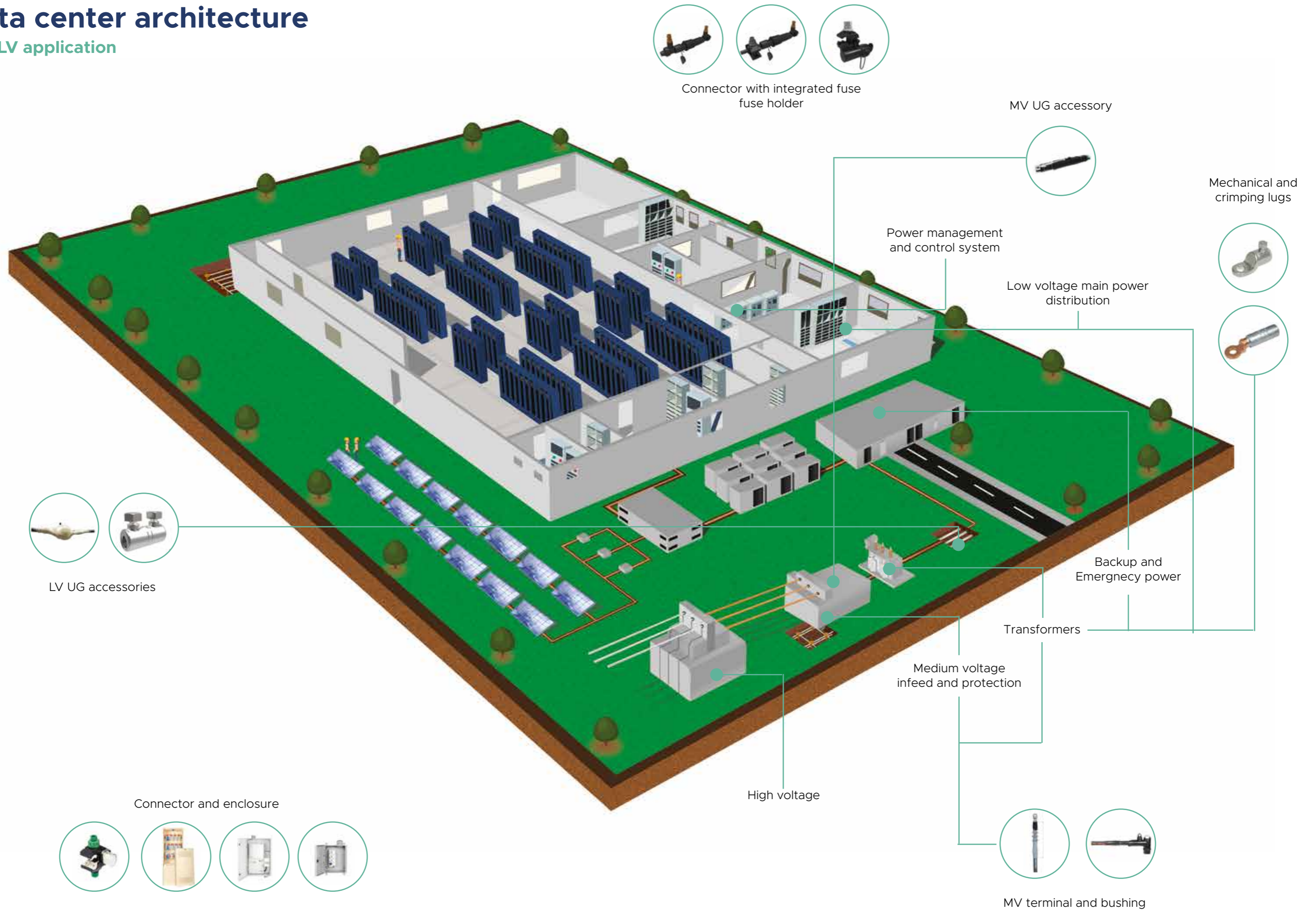

Our best asset, flexibility and adaptability to unique needs

Our expert field team at the service of your project

Aware of the issues faced by the utilities to maintain networks efficiency on daily basis, we have the expertise and offer diversity to provide you with a personalized solution.



Traceability for reliability

A reliable traceability system brings responsibility and quality-conscious focus to all the actors involved into installing accessories.

Sicame has developed robust and efficient traceability systems board on up to date technologies (datamatrix codes, mobile and web apps, GPS...). Traceability becomes hassle-free and can now be deployed thoroughly.

Advice and engineering

Our experts will provide you with support all throughout your projects and with effective and secure use for our product ranges.

Recommendations on the products for your installation projects

In each of our areas of activity our specialists can advise you on the technical solutions best suited to your technical requirements:

- Network configurations
- Standards for premises installations
- Climatic constraints
- Geographical constraints



We care about providing you perfect kit definition:

1 Need definition

We listen to your needs and expectations for your project and are here to discuss the best draft of your future solution from our advise and expertise:

- Conductor type
- Working method

2 Solution investigation & definition: adaptability and customized offer

- Kit definition:
 - Connector fit
 - Sealing technology
 - Accessory type & application
- Instruction
- Prototyping
- Laboratory testing

3 Live pilot

- Real condition testing on the field

4 Final product

- Move from live testing to industrialization and production

5 Field deployment

- On-site deployment coaching and support
- Jointsers specific training

Your benefits



Optimisation of CAPEX & OPEX indexes of your project budget



Guarantee of a qualitative solution



Durability



CHECK me
by SICAME

Check me

Also discover our new traceability platform Check me. You can thus plan and ensure the follow-up of the performances of the network, the complete traceability of accessories installed on the park, and manage your team qualification and their equipment sustainability.

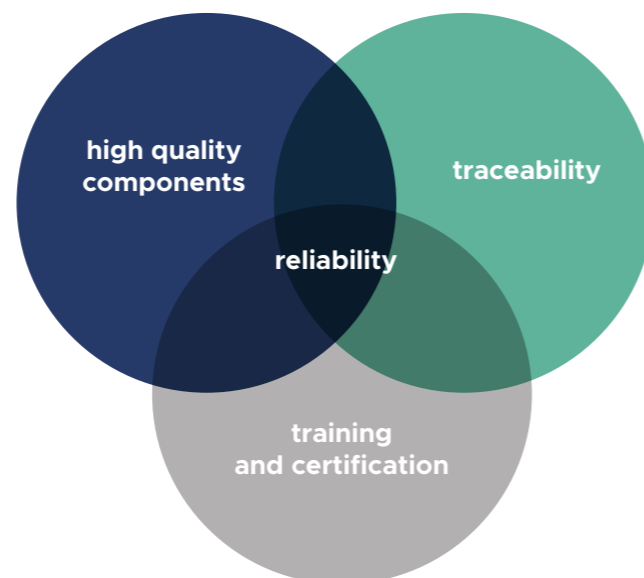

Watertightness

Technologies

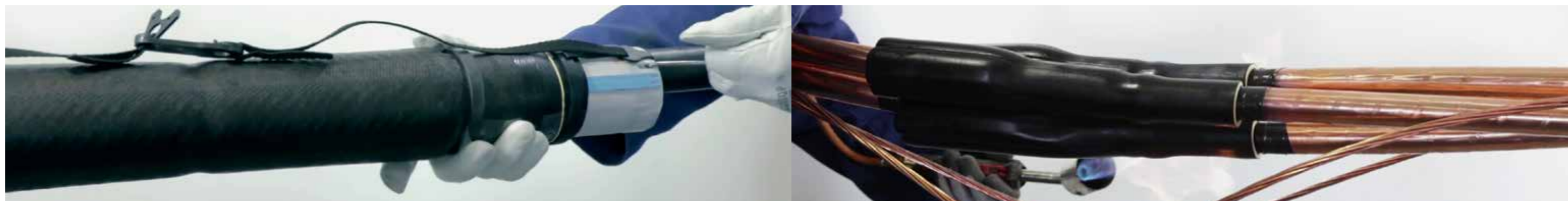

Cold shrink technology

- Easiest and quickest assembly
- Extremely reliable
- Product customization for individualized needs
- Limits misassembling risks

Material selection to maximize robustness

EPDM rubber

Naturally, EPDM materials present superior properties when it comes to mechanical strength, tear resistance and high molecular resistance to humidity. This is why EPDM material is commonly the best solution for below grade applications such as joints and derivations.

Silicone rubber

Presenting high performance with elasticity and hydrophobic behaviour, silicone is typically suitable on outdoor and indoor terminations, cold shrink, and push on.

Full range of cold shrink accessories for splices and terminations for networks up to 36 kV & cables up to 630 mm².

JUPRF: the best all-in-one joint

JUPRF cold shrink joint is the most acclaimed all-in-one joint on the market. Its unique conception reduces the number of installation steps to an unmatched low in the market.

JUPRF has passed all of the most severe tests including robustness and bending. JUPRF is an all-EPDM that maximizes joint protection against water ingress. JUPRF is so easy to install that it has been vastly adopted by field crews.

JTpRFI: transition joints made simple

Transition joints are typically complex and tedious to install. Not anymore, JTpRFI has combined the best techniques at each step of the installation:

- The mastic to prepare the cables
- The cold-shrink electrical bodies
- Easy to set-up injected resin protection

With this Hybrid solution, jointers save time and gain peace of mind knowing that each joint is the highest quality, and perfectly protected.

EUxRF: termination with patented application technique

Sicame has developed a unique and patented system to apply cold shrink terminations that eliminates the most frustrating part of it: "the zip" spiral. This new and improved application technique is associated with high quality silicone rubber for a long lasting termination even in the most difficult environments.

Heat shrink technology

- Installation at low temperature
- Long shelf life
- Three-layer tube

Technology of head shrink rubber materials

Sicame heat shrink material is a mixture of rubber and thermoplastic.

In crosslink process, the rubber vulcanizes normally but not the thermoplastic: it just stays in crystalline nature, making a bond between molecules of rubber. When heated, the crystals of thermoplastic melt and the bonds between rubber molecules are cut, allowing the rubber to get back to its initial elasticity.

Full range of heat shrink accessories for splices and terminations for networks up to 36 kV & cables up to 630 mm².

Joints - 1 & 3 cores - JxPTH series

Sicame heat-shrink joints include a unique 3-layers HS tube performing the electrical function of the accessory in a single step. This keeps the number of installation steps to a minimum, and secures the electrical function of the joint.

Branch joints and transitions

On top of the regular straight joints, Sicame has developed a complete set of transition and branch (Y-type, H-type) accessories. Based on the same 3-layers tube principle as the straight joints, these transition and derivation accessories save you time and allow you to accommodate legacy conductors with new generations in the best conditions.

Heat shrink terminations

Sicame offers a complete range of heat shrink terminations accommodating single and 3-cores configurations, XLPE and PILC conductors as well as, indoor or outdoor applications with various level of pollution. Thanks to the modular build of our terminations, the range is able to cover every common network application.

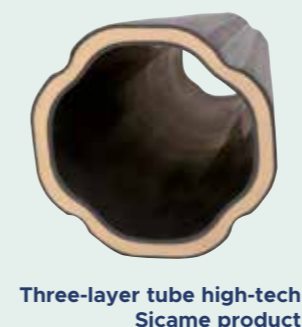

Three-layer tube high-tech Sicame product

3-layer joint body in Sicame Joints & Transitions

Cold or Heat Shrink. Extruded in mainly EPDM rubber material. Unique product where competitors require 2 or 3 tubes for the same result.

3 layers of the tube:

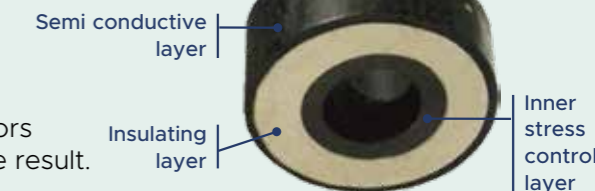

Watertightness

Technologies

Our resin are designed for 100% reliability

Sicame Group has developed dedicated research centers for the development of cast resins in accordance with our customers specifications.

We are formulating and manufacturing various cast resins for medium and low voltage applications. Our resins are formulated and professionally tested in our in-house laboratories for highest reliability and optimal handling. All our formulations are created in accordance with the REACH classification of the European Chemical Agency (ECHA).

In more than 90 years, we achieved a great knowledge about raw materials and formulations to reach a high level of expertise. We can provide a large range of polyurethane, hydrocarbon, epoxy and acrylic resins that are now recognized as best in class by our customers.



- HDI based polyurethane resin "PUR"
- MDI based polyurethane resin "PUR"
- Polybutadiene (or hydrocarbon) based resins
- Epoxy based resins
- Silicone based resins
- Acrylic based resins

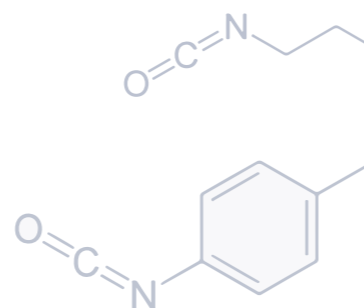

"In 2013 we took a stand to propose mostly resin with HDI hardener in partnership with Enedis, which is recognized to be less harmful, for a greater comfort for the jointers."



Our products are **free from solvent and heavy metal, resistant to environmental influences as well as electrically and mechanically stable.**

They offer long-term protection in terms of insulation values and resistance for all kind of cable accessories and cross sections.

The cast resin develops a low to non exothermic cure with excellent adhesive qualities.

We also take special care in the selection process of our packaging, for **optimal conservation, perfect mixture and ease of use on-site:**

- The cast resins are further available individually in chamber bags.
- The mixing of the cast resin component and the hardener is done directly before the filling into the joint shell which is designed with at least one filling port.

Connection

Technologies

Mechanical Connectors

Since the substitution of medium voltage paper cables by polymeric cables, a highly increasing number of different cable types are used in the world. To connect MV cables with different conductor material, shapes and cross sections, mechanical connectors are a good solution to this technical challenge. A variety of Sicame mechanical connector designs had been developed.



Complete range of cable range-taking mechanical connectors and terminations for MV cable conductors, with the patented universal shear head screw for either a ratchet or impact wrench installation.



- Design features/benefits.
- Manufactured from solid, profiled aluminium alloy extrusion.
- One piece manufacture.
- Three thread sizes: M16 / M18 / M22.
- Ease and speed of manufacture.
- Screws shear flush/recessed within connector body.
- Integral moisture block.
- Shear screws can be removed after installation.
- Aluminum or copper cable configurations.
- Multiple cable configurations.

- Cable range taking
- Torque limiter / impact wrench compatible
- High torque / large cable, low torque / small cable

Separable Connectors

As a result of the different models of bushings and the varying field requirements, different versions of separable connectors are available. Sicame offers separable connectors that are elbow-shaped, straight or T-shaped. In many cases, the insulation bodies made of EPDM rubber are multi-ranged and can be combined with mechanical cable lugs with shear-off bolts.

For connection of MV single-core cables with synthetic insulation to transformers, cubicles, compact substations, motors, etc.



- **CSE 250 / CSD 250:** 12 and 24 kV for A interface type in accordance with EN 50180 and EN 50181 standards. For single core synthetic insulation cables without armor

- **CSE 400:** 24 and 36 kV for B interface type in accordance with EN 50180 and EN 50181 standards. For single core synthetic insulation cables

- **CST 630:** 24 and 36 kV for C interface type in accordance with EN 50180 and EN 50181 standards. For single core synthetic insulation cables

- One-piece connector made of insulating EPDM rubber with semi-conductor screen
- Indoor and outdoor installation in any position.
- Connectable/disconnectable under no-load and no-voltage conditions
- Test point for voltage status monitoring
- Fixture device on the bushing
- Energization only after plugging on the bushing

Piranha™ Series

Parallel In-line waterproof, fully insulated piercing connector

Description and application:

A general purpose multiport waterproof insulation piercing connector, ideal for use in wet areas or in areas subject to casual submersion (i.e. connection pits, hand-holes and manholes). It will provide a waterproof connection for multiple single core copper or aluminium cables without the need to strip the cable or apply heat-shrink, resins or gels.

New features:

- Fully insulated, no exposed live parts
- One-piece, thermoplastic rubber over-moulding provides long-lasting water-tight seals
- All seals are pre-greased with silicone grease
- Fully insulated, rugged 13mm/19mm AF plastic shear-head bolts suitable for installation with a battery operated impact wrench
- UV stabilised over-moulding. Can be used in both overhead and underground applications
- No stripping of cables required
- No gels, resins or heat-shrink required
- Only basic tools needed

Cable types:

Single insulated, or double insulated PVC/PVC or PVC/XLPE copper or aluminium to or equivalent.

Connection ports:

- 2 mains/service ports. Each connector can connect up to 2 single core cables (of the same phase) to each other
- 3 mains/service ports. Each connector can connect up to 3 cables (of the same phase) to each other
- 4 mains/service ports. Each connector can connect up to 4 cables (of the same phase) to each other
- 5 mains/service ports. Each connector can connect up to 5 cables (of the same phase) to each other
- 6 mains/service ports. Each connector can connect up to 6 cables (of the same phase) to each other
- 2x2 mains/service ports. Each connector can connect up to 4 cables (of the same phase) to each other

Contact type:

Torque controlled insulation piercing shear-head bolts on all ports.

Test specification:
ANSI C119.1



PHMS2-6-50



PHMS3-6-50



PHMS4-6-50



PHMS4-16-95



PHM4-95-300



PHM5-16-95



PHM5-95-240



PHM6-16-240

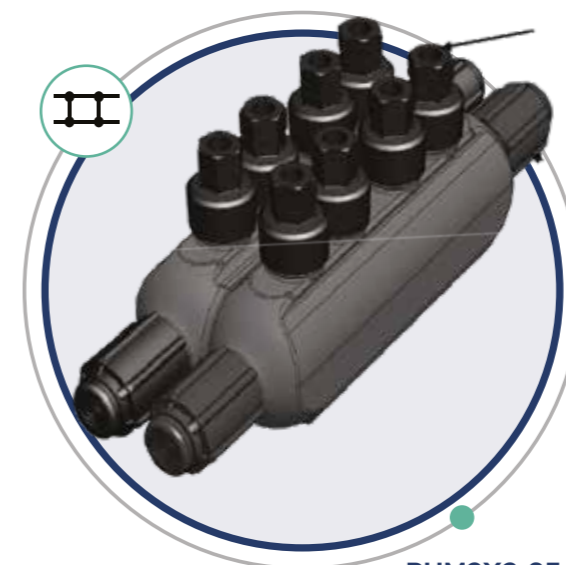

PHM2X2-95-240



PHS2-6-50
PHS2-35-185

Reference	Cable ports	Cable range*	Product dimensions		
			Length (mm)	Width (mm)	Height (mm)
PHMS2-6-50	2	6 to 50 mm ²	165	35	60
PHMS3-6-50	3	6 to 50 mm ²	160	53	63
PHMS4-6-50	4	6 to 50 mm ²	165	60	62.5
PHMS4-16-95	4	16 to 95 mm ²	160	70	113.30
PHM4-95-300	4	95 to 300 mm ²	162	110	171
PHM5-16-95	5	16 to 95 mm ²	196	140	95
PHM5-95-240	5	95 to 240 mm ²	207	155	100
PHM6-16-240	6	4 x 16 to 95mm ² 2 x 95-240 mm ²	224	160	95
PHS2X2-95-240	4	95 to 240 mm ²	310	92	100
PHS2-6-50	2	6 to 50 mm ²	148	36	82
PHS2-35-185	2	35 to 185 mm ²	285	48	95

*All Piranhas™ are designed for use on low voltage (0.6/1kV) single core cables, or a single core from a multi-core LV cable. Cable types and ranges are indicative only. Suitability of cable type and size should be confirmed with Sicame Australia prior to application.

Not suitable for flexible or welding cables.



LV Straight joint (JRSM RF)

With inline mechanical connector and cold shrink tube

Features:

- Easy installation
- No special tool is required
- No specialization skills are not required
- Fast installation
- Time saving

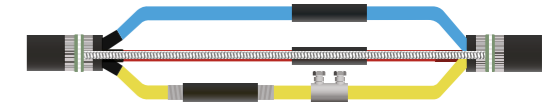

LV TEE joint (JRTM RF)

With insulation piercing connector

Features:

- Easy installation
- No special tool is required
- No specialization skills are not required
- Fast installation
- Time saving

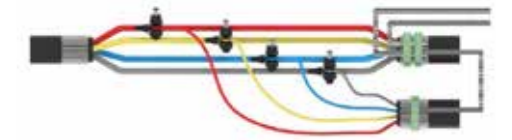

Mechanical in-line connectors

In-line connectors - MFLV

Standards
IEC 61238-1

Features:

- Tinned aluminum alloy body and aluminum alloy screws
- Shear head screw for F versions. For other versions, hexagon socket head screws
- The UB versions are without a central blocking part and with a viewing hole
- Small size, particularly suitable for heat-shrink and cold-shrink joints
- Fittings for aluminium or copper cables, round or sectoral, stranded class 2 or solid class 1
- Tightening fuse screws with a standard manual socket or an impact wrench
- The breakage of the fuse heads always remains in the volume of the coupling (without ever exceeding 2 mm), and avoids the risk of damaging the insulation

Installation:

- Strip insulation from the bore equal to the depth of the bore
- Wire brush the exposed conductor core and wipe clean (optional)
- Align and position the conductor core into the bore ensuring that the core is fully inserted
- Torque tighten the shear screws consecutively one turn at a time until the bolts have sheared
- De-burr and clean the conductor as appropriate



Reference	Cable range Al / Cu (mm ²)	HEX Head
		'DA/F'
MFLV 10-50 F	10-50	13
MFLV 25-95 F	25-95	13
MFLV 35-150 F	35-150	17
MFLV 95-240 F	95-240	17
MFLV 185-300 F	185-300	19
MFLV 240-400 F	240-400	22



Permanent grounding and bonding

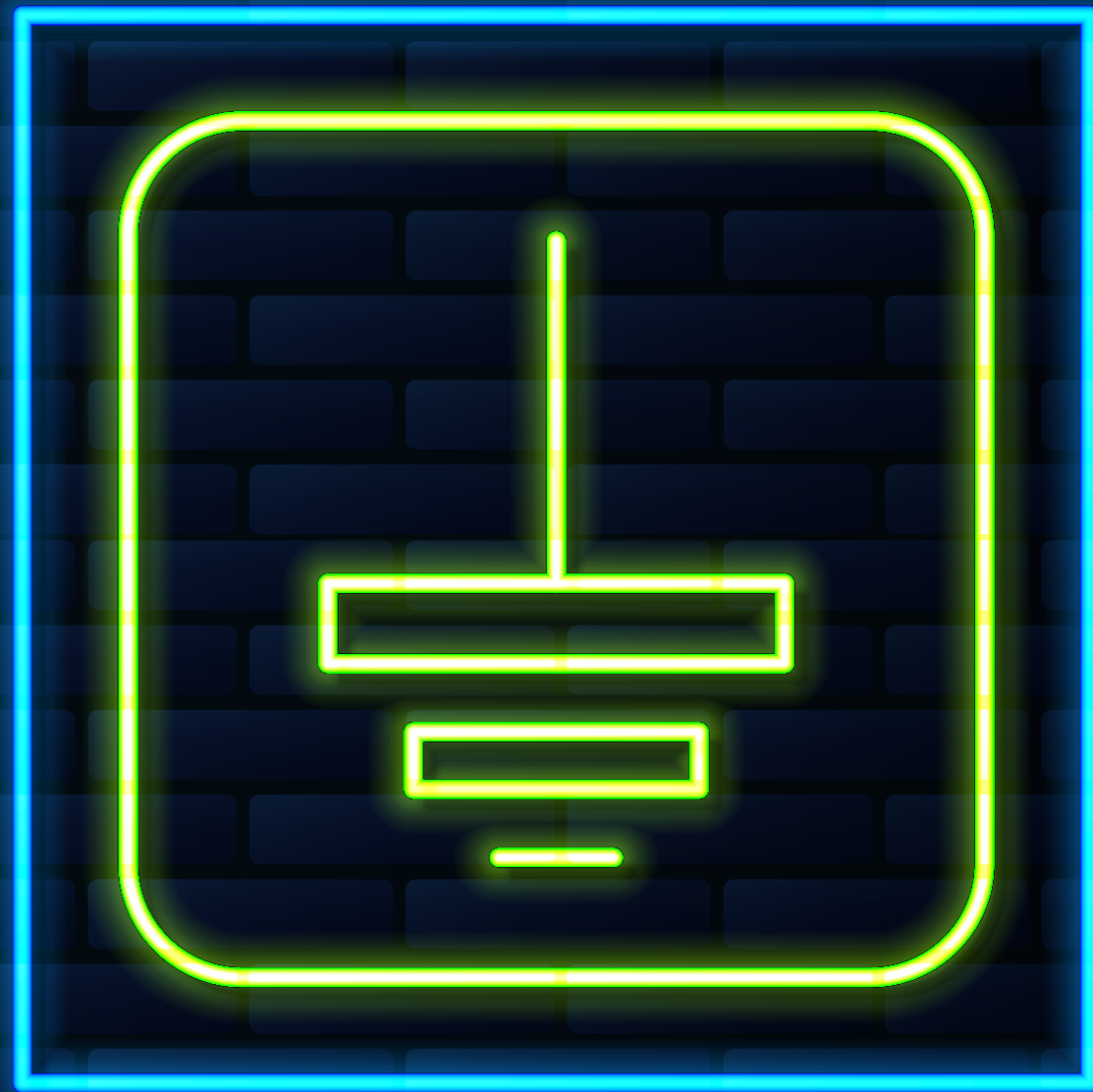

Data center architecture

Grounding accessories



Crimping connections



Bonding systems for cable tray
Wire clamps SF / FClip / TClip

Vertical or horizontal earthing
Earth rods or earth grids meshes



Bonding systems for metallic
enclosures earth braids

Bonding systems solar panels SOLFIL

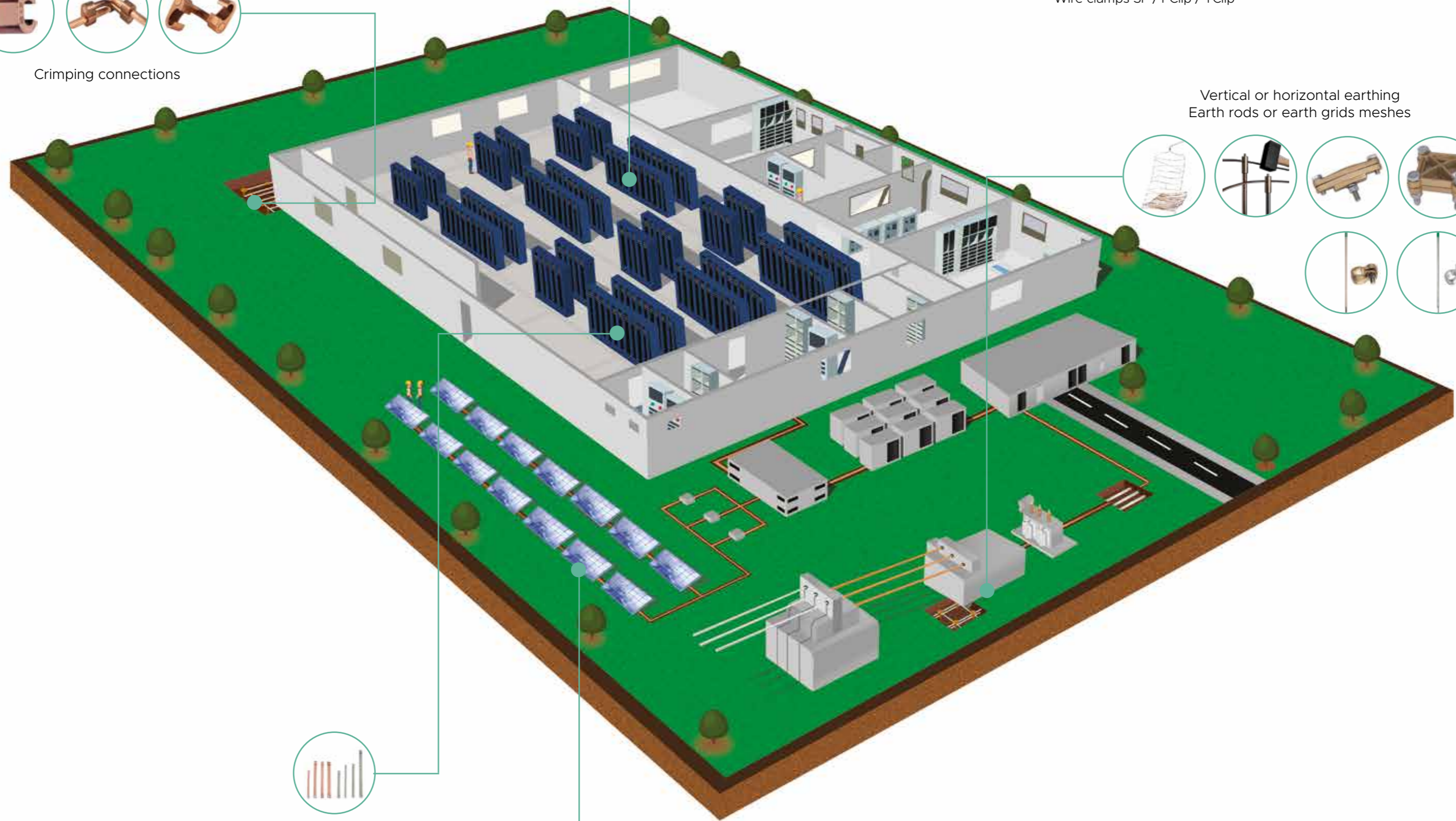

Vertical earthing

The rod is, in most cases, the most practical, effective and reliable earth connection mean.

Highly effective: for a given contact surface area, the linear type electrode provides, both theoretically and practically, the least earth resistance. Furthermore, it enables the most moist and conductive layers to be reached. Easy and quick to install, it requires no earth work. Even inside industrial buildings, it is often possible to install an earth rod exactly where required by breaking through a small area of the floor.

Accessible and testable connection: the use of an inspection box makes it possible to leave the head of the rod and its connection unburied and to periodically test it and measure its resistance.

Self-extending copper-steel rods

Application:

- For the evacuation of fault currents to earth
- Self-extending rods: the lower end of each rod has a point intended both for driving in and connecting; the upper end is pierced, receiving, without any sleeve, the point of the previous rod

Features:

- Steel with copper electroplating: minimum thickness 350 µm
- Resistance: ≥ 70 daN/mm²

Accessories:

- Driving pins: CH-MZ, CH-LMZ and CH-MP
- Connection terminals: C2C-95Z, TO-2-19 et TO-3-16/19

Cupro-aluminum



A3MC-10Z



Reference	Type	Ø (mm)	Length (m)	Weight (kg)	Connection
A3MC-10Z	Self-expandable	17.3	1	1.8	Cupro-aluminum
A3MC-15Z			1.50	2.75	

Connector heads for earthing rod

Application:

- Head/rod connection obtained by conical press-fitting with force
- Head/cable connection made by striking a stainless steel peg located in the upper part of the head. This strike guarantees the connection head/posts and head/cable
- For earthing rods: Ø 17,3 mm copper-steel and Ø 16 mm stainless-steel
- Model TFTI-16/17: the head/rod connection fits inside the earthing rod

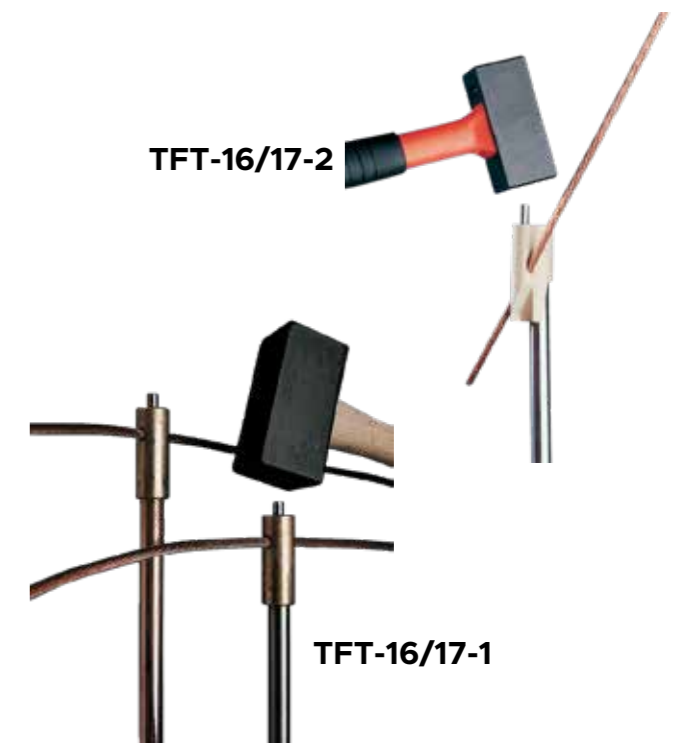

Self-extending stainless steel rods

Application:

- For the evacuation of fault currents to earth
- Self-extending rods: the lower end of each rod has a point intended both for driving in and connecting; the upper end is pierced, receiving, without any sleeve, the point of the previous rod

Features:

- Material: stainless steel EN 1.4028 (Z30 C13)
- Resistance: $\geq 90/100$ daN/mm²

Accessories:

- Driving pins: CH-LMZ (small model), CH-MZ (large model), CH-MP (with handle)
- Connection terminal: B-CHROM model

B.CHROM



AMI-10



Reference	Type	Ø (mm)	Length (m)	Weight (kg)	Connection
AMI-10	Self-expandable	16	1	1.45	B.CHROM
AMI-15			1.50	2.2	

Horizontal earthing

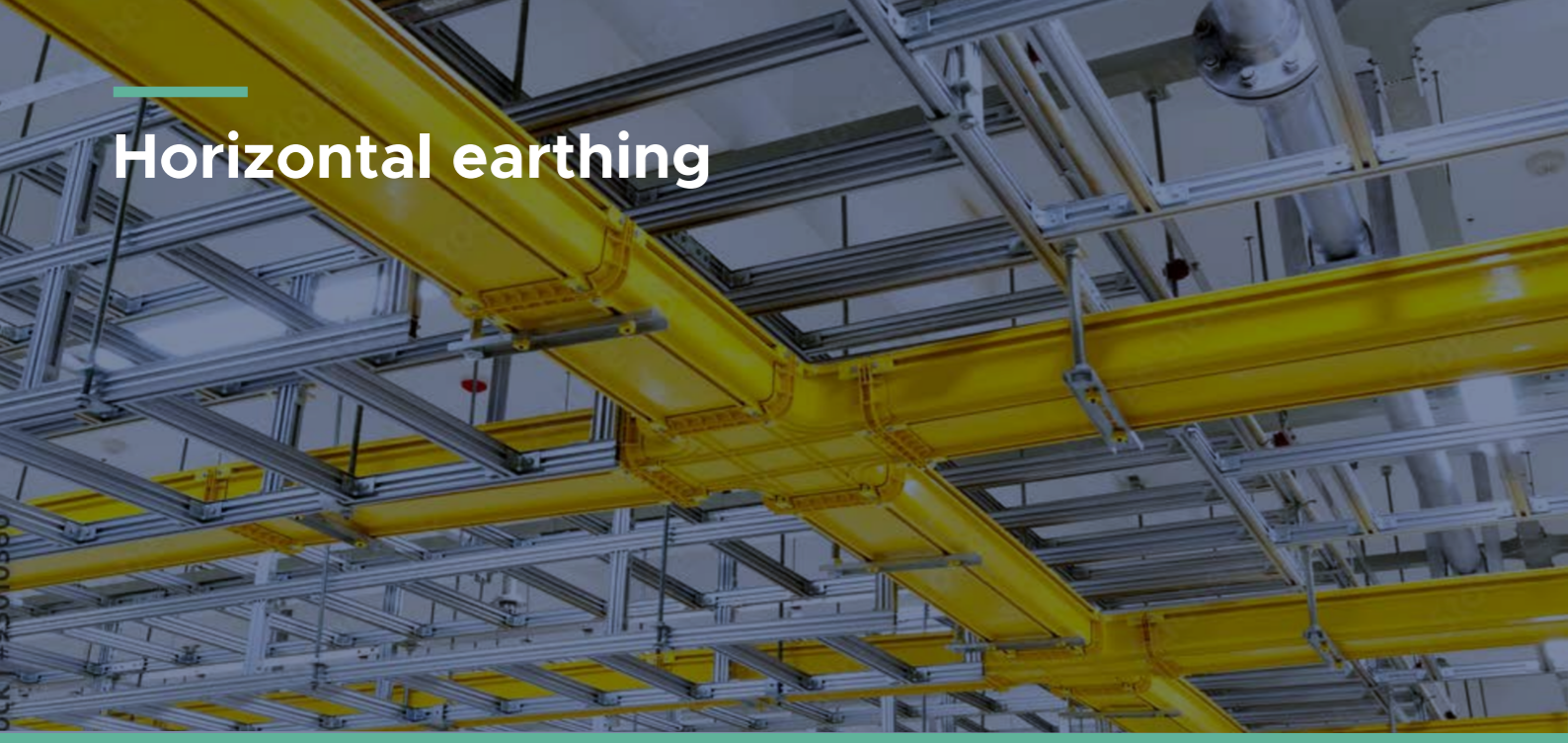

Earth grids meshes

Application:

- Ensures the proper flow of lightning currents or 50 Hz fault currents to earth
- Prevents the formation of harmful cavities on the contact surface

Features:

- Made of copper wires and cable
- A longitudinal link made of galvanized steel wire Ø 1 mm holds the ellipses in place. It ensures the rigidity of the grids

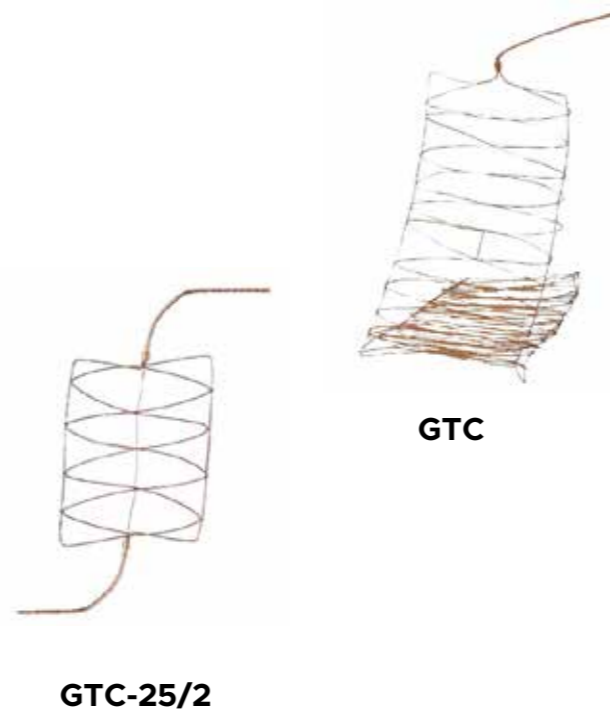

Reference	Width (mm)	Length (mm)	Connecting cable (m)	Weight (kg)
GTC-6	450	600	2 m long connecting cable	1.4
GTC-14	460	1 400	2 m long connecting cable	1.8
GTC-25/1	460	2 500	29 mm ² sleeve	2.8
GTC-25/2	400	2 500	0,5 m long connecting cable (x2)	2.5
GTC-25/4	460	2 500	4 m long connecting cable	3.2
GTC-25	460	2 500	2 m long connecting cable	2.75

Compression tap-off copper connectors type C

General features:

- Crimping tap made of pure electrolytic copper with a "C" shape enabling joints
- Taps of Cu-Cu for overhead
- Grounding connections without cutting the main cable

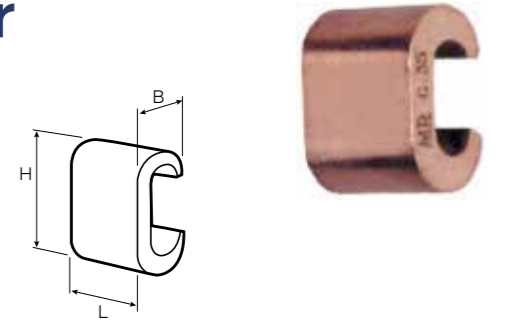

Item code	Reference	Dimensions			Main conductor mm ²		Tap conductor mm ²		Die
		L (mm)	H (mm)	B (mm)	Min	Max	Min	Max	
7340460	YC10C10	8	9.8	6.4	2.5	6	1.5	6	...HCU10
7340450	YC8C8	12.7	12.6	8.4	10	10	1.5	10	...HCU25
7340152	C16	17	19	11.5	10	16	2 x 1,5	16	...HCU70
7340180	C25PM	19	21	11.9	25	25	10	16	...HCU95
7340430	YC4C6	17.7	19.3	11.9	16	25	2.5	16	...WBG
7340420	YC4C4	17.7	21	11.9	16	25	16	25	...HCU95
7340172	C25	20	24.3	15	25	29.3	10	29.3	...HCU150
7340212	C35	20	26.5	15	30	35	25	35	...HCU150
7340400	YC2C2	21.2	26.5	15.6	35	40	35	40	...HCU150
7340232	C50	20	26.5	17.2	50	50	16	50	...HCU150
7340470	YC26C2	28	33.1	20.4	50	70	10	35	...HCU240
7340480	YC26C26	28	34.1	21	50	70	40	70	...HCU240
7340285	C95-35	30	41	26	95	100	4	40	...CC95
7340262	C75	30	41	26	75	95	30	75	...CC95
7340520	YC28C28	29	39.6	25.1	95	100	95	100	...CC95
7340337	YC29C29	30	44	27	100	125	25	125	...C120
7340336	YC31C28	27.2	44.1	27.2	150	185	25	100	...U708
7340620	YC240C120	22.4	68	34	150	240	95	120	P1011 / U1011
7340352	C150	30	45	28	150	150	75	150	...CC150
7340370	C185	35	54	33	115	185	95	185	...CC185
7340570	YC120C070	18.5	50	23.5	95	120	10	70	U997
7340560	YC120C	21.8	52.5	24	95	120	95	120	U997
7340395	YC240C070	22.4	61	31	150	240	10	70	P1011 / U1011
7340397	YC240C	32	74	34	150	240	150	240	P1011 / U1011

For plated version:

Add suffix "E" for items started with a C (example: C25: non plated, C25E: tin-plated)
Add suffix "TN" for items started with YC (example: YC4C6: non plated, YC4C6TN: tin-plated)

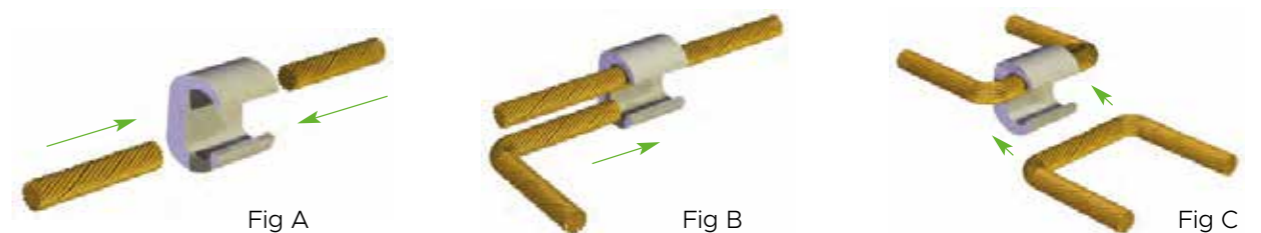

Mass braids

General features:

- Cu ETP copper thread
- Crimped copper flat wire ends
- Available in unplated or tin-plated copper



Item code	Reference	Item code	Reference	mm ²	Ø mm Threads	L mm	A mm	B mm	C mm	S mm	D1 mm
7520300	TMP6-6-100	7520340	TMPE6-6-100	6	0.10	100	13	11	5	2.0	7
7520301	TMP6-6-150	7520341	TMPE6-6-150	6	0.10	150	13	11	5	2.0	7
7520302	TMP10-8-150	7520342	TMPE10-8-150	10	0.20	150	23	17	10	2.0	9
7520303	TMP10-8-200	7520343	TMPE10-8-200	10	0.20	200	23	17	10	2.0	9
7520304	TMP10-8-250	7520344	TMPE10-8-250	10	0.20	250	23	17	10	2.0	9
7520305	TMP16-8-150	7520345	TMPE16-8-150	16	0.20	150	23	17	10	2.5	9
7520306	TMP16-8-200	7520346	TMPE16-8-200	16	0.20	200	23	17	10	2.5	9
7520307	TMP16-8-250	7520347	TMPE16-8-250	16	0.20	250	23	17	10	2.5	9
7520308	TMP16-8-300	7520348	TMPE16-8-300	16	0.20	300	23	17	10	2.5	9
7520309	TMP25-8-150	7520349	TMPE25-8-150	25	0.20	150	23	23	10	3.2	9
7520310	TMP25-8-200	7520350	TMPE25-8-200	25	0.20	200	23	23	10	3.2	9
7520311	TMP25-8-250	7520351	TMPE25-8-250	25	0.20	250	23	23	10	3.2	9
7520312	TMP25-8-300	7520352	TMPE25-8-300	25	0.20	300	23	23	10	3.2	9

For plated version:

Add suffix "E" for items started with TMP (example: TMP6-6-100: non plated, TMPE6-6-100: tin-plated)

Bonding clip for basket cable trays FClip

Features:

- Material: Steel
- Plating: Tin
- Equipotential bonding for uninsulated earthing conductor from 16 to 35 mm²
- No tools are required
- Complies with EN 61439-1
- Fixing time approximately 5 times faster than traditional methods



Reference	Conductor mm ²
FCLIP16-35	16-35

Quick and easy installation in 3 steps

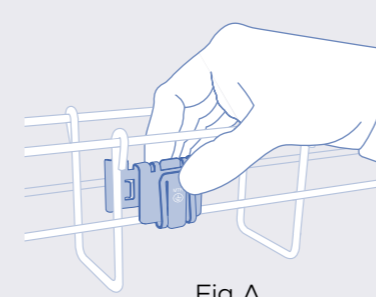

Fig A

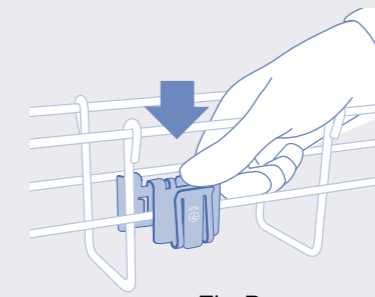

Fig B

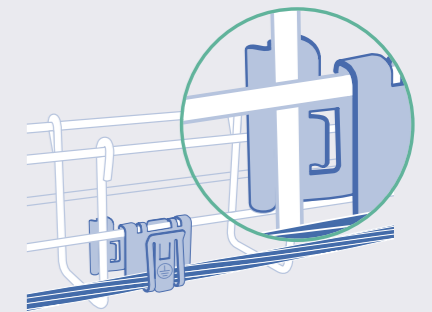

Fig C

Bonding clip for perforated cable trays TClip

Features:

- Material: Steel
- Plating: Tin
- Equipotential bonding for uninsulated earthing Conductor from 6 to 10mm² or 16 to 35 mm²
- No tools are required
- Complies with EN 61439-1
- Fixing time approximately 5 times faster than traditional methods



Reference	Conductor mm ²
TCLIP6 -10	6-10
TCLIP16-35	16-35

Find out more on our product range at www.mecatraction.com

MTR
Sicame Group

Brass earthing line supports

SF series:

Features:

- Brass earthing line supports

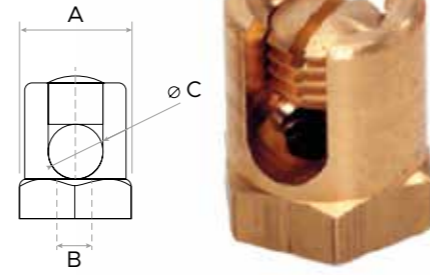

Item Code	Reference	A (mm)	B (mm)	C (mm)
7341001	SF66	17	M6	4 to 6
7341011	SF67	17	7 x 150	4 to 6
7341021	SF68	17	M8	4 to 6
7341031	SF86	19	M6	4 to 8
7341041	SF87	19	7 x 150	4 to 8
7341051	SF88	19	M8	4 to 8
7341061	SF810	19	M10	4 to 8
7341071	SF106	21	M6	6 to 10
7341081	SF107	21	7 x 150	6 to 10
7341091	SF108	21	M8	6 to 10
7341101	SF1010	21	M10	6 to 10
7341111	SF126	24	M6	6 to 12
7341121	SF127	24	7 x 150	6 to 12
7341131	SF128	24	M8	6 to 12
7341141	SF1210	24	M10	6 to 12

Item code	Reference	A (mm)	B (mm)	C (mm)
7341151	SF146	26	M6	8 to 14
7341161	SF147	26	7 x 150	8 to 14
7341171	SF148	26	M8	8 to 14
7341181	SF1410	26	M10	8 to 14
7341191	SF166	30	M6	10 to 16
7341201	SF167	30	7 x 150	10 to 16
7341211	SF168	30	M8	10 to 16
7341221	SF1610	30	M10	10 to 16
7341231	SF186	32	M6	18
7341235	SF187	32	7 x 150	18
7341241	SF188	32	M8	18
7341271	SF206	36	M6	20
7341281	SF207	36	7 x 150	20
7341291	SF208	36	M8	20
7341301	SF2010	36	M10	20

SF + BM series:

Features:

- Brass earthing line supports, with brass, stud and nut and 2 Al-Cu washers

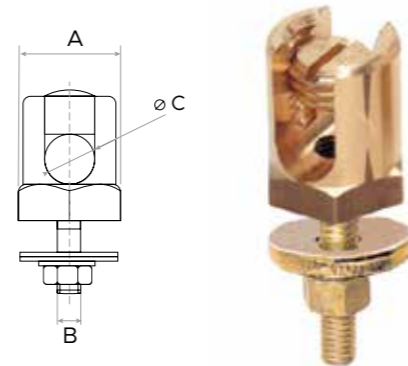

Item code	Reference	A (mm)	B (mm)	C (mm)
7341008	SF66+BM	17	M6	4 to 6
7341038	SF86+BM	17	M6	4 to 8
7341078	SF106+BM	21	M6	6 to 10
7341118	SF126+BM	24	M6	6 to 12
7341122	SF127+BM	24	7 x 150	6 to 12
7341158	SF146+BM	26	M6	8 to 14

Item code	Reference	A (mm)	B (mm)	C (mm)
7341162	SF147+BM	26	7 x 150	8 to 14
7341198	SF166+BM	30	M6	10 to 16
7341203	SF167+BM	30	7 x 150	10 to 16
7341234	SF186+BM	32	M6	18
7341278	SF206+BM	36	M6	20
7341282	SF207+BM	36	7x150	20

Tin-plated brass earthing line supports

Screws and bolts for earthing line supports

Features

SF CNM series:

- Tin-plated brass earthing line supports, with one brass stud
2 Alu-Cu washers, one brass nut and one locknut

Screws and bolts for earthing line supports:

- Brass or zinc-plated steel studs and nuts
- Zinc-plated steel flat washers



Item code	Reference	A (mm)	B (mm)	C (mm)
7341004	SF66CNM	17	M6	4 to 6
7341014	SF67CNM	17	7 x 150	4 to 6
7341024	SF68CNM	17	M8	4 to 6
7341034	SF86CNM	19	M6	4 to 8
7341044	SF87CNM	19	7 x 150	4 to 8
7341054	SF88CNM	19	M8	4 to 8
7341064	SF810CNM	19	M10	4 to 8
7341074	SF106CNM	21	M6	6 to 10
7341084	SF107CNM	21	7 x 150	6 to 10
7341094	SF108CNM	21	M8	6 to 10

Item code	Reference	A (mm)	B (mm)	C (mm)
7341126	SF127CNM	24	7 x 150	6 to 12
7341134	SF128CNM	24	M8	6 to 12
7341144	SF1210CNM	24	M10	6 to 12
7341154	SF146CNM	26	M6	8 to 14
7341163	SF147CNM	26	7 x 150	8 to 14
7341174	SF148CNM	26	M8	8 to 14
7341184	SF1410CNM	26	M10	8 to 14
7341194	SF166CNM	30	M6	10 to 16
7341207	SF167CNM	30	7 x 150	10 to 16
7341214	SF168CNM	30	M8	10 to 16

Earthing for substation

Crimping tap-off type C copper



Cable to cable cross-section mm ²					
Reference	Min	Max	Min	Max	Die
YGL035C035	10	35	10	35	U-0
YGL120C035	40	120	10	35	U997
YGL120C120	35	120	35	120	U997
YGL240C035	120	240	10	35	P998
YGL240C120	120	240	35	120	P998
YGL240C240	120	240	120	240	P1011 / U1011
YGHP035C035	10	35	10	35	U-0
YGHP120C035	50	120	20	35	U997
YGHP120C070	50	120	50	70	U997
YGHP120C120	50	120	95	120	U997
YGHP240C035	120	240	20	35	P998
YGHP240C070	120	240	50	70	P998
YGHP240C120	120	240	95	120	P998
YGHP240C240	120	240	185	240	P1011/U1011

Copper connector cable to structure



Reference	Cable cross - section mm ²		Bolt size	Torque N.m
	Min	Max		
GB016070M8C	16	70	M8	15
GB016070M12C	16	70	M12	60
GB070120MBC	70	120	M8	15
GB070120M12C	70	120	M12	60
GB070120M16C	70	120	M16	140
GB120150MBC	120	150	M8	15
GB120150M12C	120	150	M12	60
G8150240M12C	150	240	M12	60

Copper connector 2 to 4 cable to structure



Reference	Cu cable cross - section mm ²		Bolt size	Torque N.m
	Min	Max		
STN070120C	70	120	M12	60
STN120150C	120	150	M12	60

Copper connector bar to structure



Reference	Cable cross - section mm ²		Bolt size	Torque N.m
	Min	Max		
HFBC40	30 x 4	40 x 5	M8	15
HFBC50	50 x 5	50 x 5	M8	15

Reference	Cable cross-section mm ²		Bolt size	Torque N.m
	Min	Max		
HHBIC40C	30 x 4	40 x 5	M6	10
HHB1C50C	50 x 5	50 x 5	M6	10
HHB1CS0E1C	50 x 5	50 x 5	M6	10



Safety solutions and equipment against electrical risks

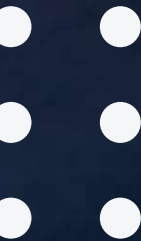

Data center architecture

Safety accessories

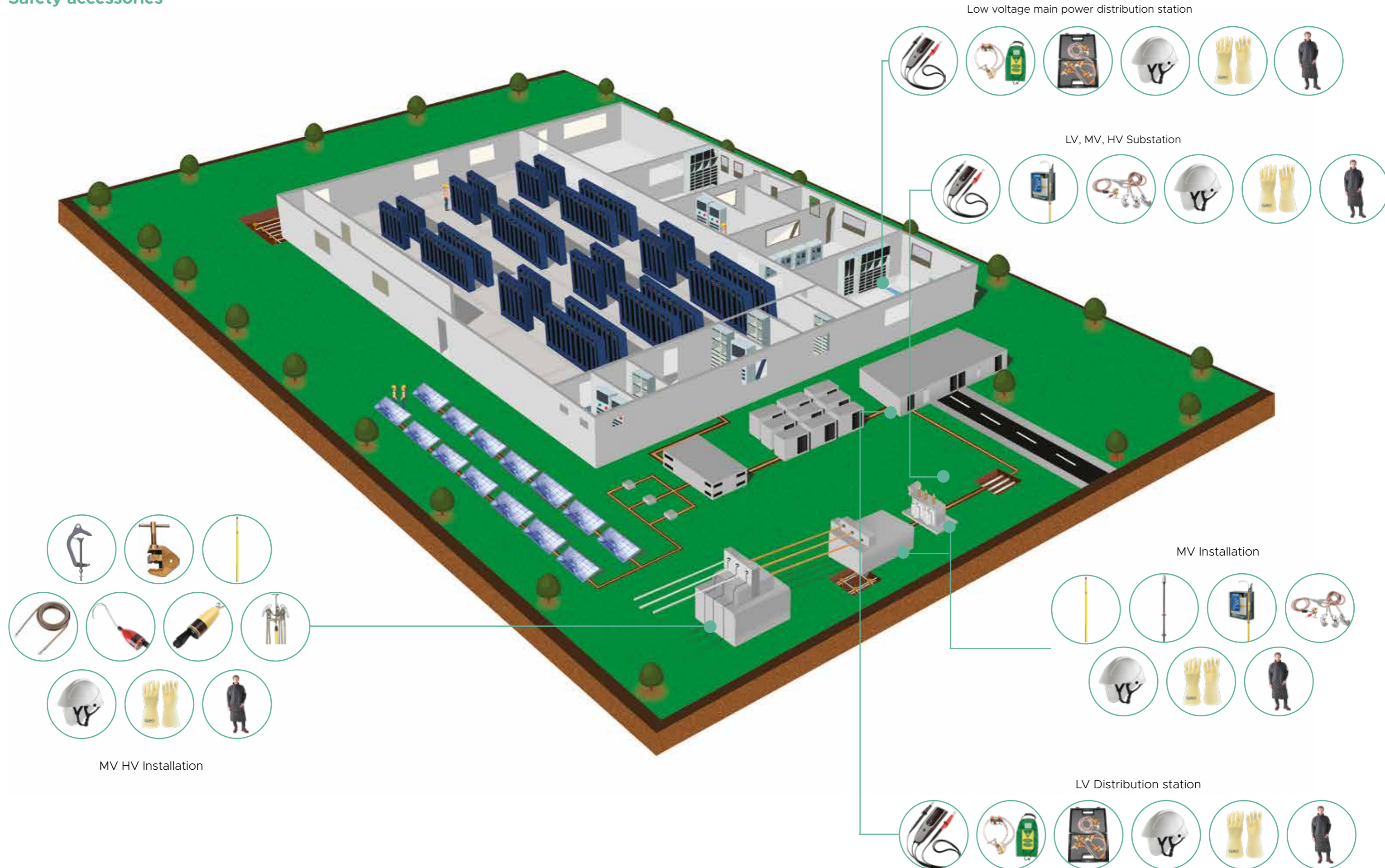



Personal and collective protective equipment

Insulated Arc Flash safety helmet with integrated face shield for electrician (APC 1) MO-185-BLM

Application:

- Head protection: mechanical protection and insulating protection in case of contact with live parts
- Face protection against arc flash hazard

Features:

- Insulated shell until 20 kV (ANSI Z89.1) and EN 50365
- Mechanical shocks properties conforming EN 397
- Arc flash face shield totally retractable inside the helmet. Height of the screen 18 cm
- Anti-scratch and anti-fogging face shield
- 4 points chinstrap around the ears with easy locking buckle
- Adjustable head band thanks to the ratchet

EN 166 / EN 170
EN 397
EN 50365
IEC 61482-1-2 / GS-ET29
ANSI Z89.1
UKCA
CE



Insulated Arc Flash safety helmet with integrated face shield for electrician, (APC 2/ATPV 14 cal/cm²) MO-180-ARC-12

Application:

- Unique patented solution by CATU to protect eyes, face and head against thermal arc hazards of an electric arc

Features:

- Insulated shell until 20 kV (ANSI Z89.1) and EN 50365
- Mechanical shocks properties conforming EN 397
- Thermal arc protection according to both test methods:
 - IEC 61482-1-2 APC 2 (Arc Performance Class);
 - IEC 61482-1-1 ATPV 14 cal/cm² (Arc Thermal Performance Value).
- Face shield protection against electrical arc, fully retractable inside the shell
- Chin-strap with 4 attachment points for comfortable ear positioning and with user friendly clip locking system
- Adjustable size by mean of a ratchet

EN 166 / EN 170 / EN 397
EN 50365
IEC 61482-1-2 / GS-ET29 / ANSI Z 89.1
ASTM F2178 / IEC 61482-1-1
NFPA 70E
UKCA
CE



CAT'ARC multi-risk clothing to protect against an electric Arc

Application:

- Multi-risk protection: protection against thermal hazards of an electric arc, heat and flames, welding hazards and with antistatic property
- Prevention of the worsening of an accident by quickly and easily removing the jacket or the coverall thanks to the red **anti-panic zip**
- Adjustable to all body types: cuffs that can be tightened, elastic waist, adjustable length of inner leg (77 cm or 82 cm)

NFPA 70E
IEC 61482-2
ISO 11612:20015 A B1 C1 E2 F1
ISO 11611 Class 1
EN 1149-5
ASTM F1959
ASTM F1506
CE

Features:

- A high collar and adjustable cuffs improve the garment's high protection.
- Hard-wearing clothing thanks to the reinforcements at the knees, and crotch.
- Numerous features: 1 chest band, numerous pockets
- Standard pictograms clearly visible on the left sleeve



AFG-1001*



AFG-2000*



AFG-2001*



AFG-2300**

CAT'ARC APC 2 ATPV 12 cal/cm²



AFG-4000*



AFG-4001*



AFG-4300**



AFG-HOOD*

CAT'ARC APC 2, ATPV 25 cal/cm² & 40 cal/cm²

(*) To be completed by the size: XS, S, M, L, XL, 2XL, 3XL, 4XL or 5XL.

(**) To be completed by the size: S, L, 2XL, 4XL.

Safety shoes with insulating sole

Application:

- Safety shoes, low and leather type, providing electrical hazard resistance up to 18 kV according to ASTM F2413
- Mechanical shocks properties conforming EN ISO 20345
- To be used indoor or in a dry environment
- Safety shoes with insulating sole specifically designed for the electricians, industry, building, oily and smooth soils

Features:

- **Each insulating sole tested at 5 kV**
- Shoes with leather and breathable liner microphone
- Anti-penetration textile sole
- Protection cap 240 J (20% above the standard)
- Slip resistance: SRC. Torsion resistant sole

EN ISO 20345
ASTM F2413-11 (18 KV)
CE



MV-222*

MV-223*



* Add size (39 to 47) to the reference. Ex: MV-222-43.

Electrical insulating rubber electrical gloves

Application:

- Wellfit finish: soft, supple, durable and ergonomic with high flexibility for an easy work
- Convenient to any hand shape
- Gloves without extra-mechanical protection; to be worn with leather overgloves **CG-981** and **CG-991** to ensure full mechanical protection

Features:

- Electrical insulating gloves
- Cut edge CG-05 & 10
- Roll edge CG-1 to 4 (color natural inside and red outside)
- Material: natural color latex ensuring highest dielectric features
- Traceability through flashcode on color-coded label
The color is according to the class
- Category: AZC (Acid, Ozone, Cold resistance) for CG-05 RC for other classes

EN 60903
IEC 60903
UKCA
CE



CG-05* CG-10*



CG-1**-NR
to CG4**-NR

(*) Complete by size code **A=8, B=9, C=10, D=11.**

(**) Complete by size code **08 to 11 (Sizes 7 and 12 on request).**

Reference	Class	Color Label	AC (V)	DC (V)
CG-05-*	00	Beige	500	750
CG-10-*	0	Red	1 000	1 500
CG-1**-NR	1	White	7 500	11 250
CG-2**-NR	2	Yellow	17 000	25 500
CG-3**-NR	3	Green	26 500	39 750
CG-4**-NR	4	Orange	36 000	54 000

Leather overgloves for insulating gloves

Application:

- The overgloves ensure mechanical protection for insulating gloves CG-05 & CG-10 = CG-981*, and for CG-1 to CG-4 = CG-991*
- They are resistant to flame and contact heat of 100°C for 10 s according to EN 407
- Velcro® at the cuff adjusts the tightness of the glove to the user's hand

Features:

- Silicone goat grain leather, para-aramid thread stitching
- Wide protective cuff in cowhide crust (10 cm long)
- American assembly, nested thumb.
- Adjustable width by fireproof Velcro® strap mounted on leather
- Grey color
- Complies with standard EN 388: 2122X
- Complies with standard EN 407: 412X4X
- Level of dexterity according to EN 420 A1: 5 (excellent grip)

EN 407
412X4X
EN 388
2122X
EN 420
UKCA
CE



CG-981 or CG-991*

* Complete by size code **08 to 11**



Insulating, mechanical and Arc flash insulating gloves

Application:

- Resistant: latex with reinforced mechanical protection against tearing. To be used without overgloves («composites» insulating gloves)
- Wellfit finish: soft, supple, durable and ergonomic with high flexibility to ease the work
- Convenient to any hand shape
- Thermal arc protection according to both test methods:
 1. IEC 61482-1-2 APC 2 (Arc Performance Class);
 2. IEC 61482-1-1 ATPV 12 cal/cm² (Arc Thermal Performance Value) CGM-00 to CGM-4 or IEC 61482-1-1 ATPV 40 cal/cm²: CGM-4(**)-ARC-40

EN 60903:2004 / IEC 60903
ASTM F2675
ATPV 12 and 40 cal/cm²
IEC-61482-1-2 APC 2
UKCA
CE

Features:

- Electrical insulating gloves, class 00 to 4. Protection against electric arc
- Cut edge
- Material: bicolor natural latex. (exterior: orange, interior: natural)
- Traceability through flashcode on color-coded label
The color is according to the class
- Level of dexterity according to EN 420 A1: 5 (excellent grip)



CGM-00 to CGM-4

Reference	Class	Color Label	AC (V)	DC (V)
CGM-00-*	00	Beige	500	750
CGM-0-*	0	Red	1 000	1 500
CGM-1-*	1	White	7 500	11 250
CGM-2-*	2	Yellow	17 000	25 500
CGM-3-*	3	Green	26 500	39 750
CGM-4-**	4	Orange	36 000	54 000

Complete by size code *08 to 11 and **9 to 11

Pneumatic tester for insulating gloves

Application:

- For compulsory control of insulating gloves before use
- Checking is done by inflating and immersing in water the insulating gloves
- Device recommended by standard IEC 60903:2014 for the periodic testing of insulating gloves from class 00 to 4

Features:

- Body of molded thermosetting material resting on a circular collar and comprising a frustoconical tip with two grooves for receiving the glove to be tested
- Central piston located at the base of the unit
- Soft valve located at the bottom of the bowl, at the top
- Maintenance of the insulating glove in position when inflated by two elastic rings



Transport box and wall box for insulating gloves

CG-35/2

Application:

- Plastic box for insulating gloves from class 00 to 4
- Ensure the gloves have a good mechanical protection against shocks and U.V. radiation
- Box can be mounted on a wall, in a substation, or be used as a carrying storage box

Features:

- The transparent cover enables to check gloves presence
- Ergonomic lock for an easy opening
- Quick fixing of the gloves with a professional Velcro® strap to avoid any glove damage
- Multilingual labels to stick on the cover in the appropriate area ; on these labels are written the maintenance recommendations according to IEC 60903



Electric lockout kit

KIT-CONSI-01E

Application:

- Provision for lockout on low-voltage electrical works in application of the safety requirements of standard EN 50110-1

Features:

- 1 Carrying bag M-87292
- 1 Padlock with Ø 4 mm insulated shackle PP-4-38-R-Z
- 1 Padlock with Ø 6 mm insulated shackle PP-6-38-R-Z
- 1 Multiple locker AL-205
- 1 Hasp ALM-6/25
- 1 Non-conductive slider hasp with Ø 3 mm flexible shackle ALP-4/3
- 2 Small circuit breaker lockouts (with mini padlock) AL-201/C1
- 2 Medium model circuit breakers lockouts AL-208-D
- 1 Slide & Pin circuit breaker lockouts SAL-210
- 1 Multiple circuit breaker lockout large model AL-209-L
- 1 set of 10 tagout badges AP-460



Safety padlock PP-4-38

Application:

- For locking the separating devices (e.g. circuit breakers) to prevent their operation
- Padlock with insulating shackle for use in low voltage 1000 V AC - 1500 V DC: tested and validated in accordance with the electrical test IEC 60900 (2018) §5.5.3. at 5000 V
- More secure locking: impossible to drop the key when the shackle is open, the key remains trapped

Features:

- Available with a key alike (A1 to A8) or different (Z)
- Marking on both sides:
 - On one side: standard symbol
 - On the other side: area for marking user names and coordinates
- Padlock delivered with 2 keys



Signaling / delineation tape

Application:

- Allows temporary delineation of a hazardous area
- Easy to tie, to staple, or be fixed to post, face or gate

Features:

- Material: polyethylene plastic providing good tensile strength and breaking strength
- Double-sided printing with environmental friendly inks



Steel circuit breaker lockout for moulded units

Application:

- Used to lock-out circuit breakers in moulded units
- Possibility to lock the circuit breaker by several operators
Accepts 3 padlocks Ø 5 to 8 mm

Features:

- Specifically adapted for "SCHNEIDER" circuit breakers reference NS80, NSE75/NSE100, NS100/NS160/NS250, NSF150/NSF250, NS400/NS630, NSJ400/NSJ600



AL-204

Insulating mat

Application:

- Insulating mat for live and dead work
- Used to cover the floor for the electrical protection of operators in electrical installations
- Protect the workers from the ground potential
- Must be adapted to the nominal voltage of the network supplying the installation on which it is used

Features:

- In accordance with IEC 61111 standard and to specific properties of the "C" Category (extremely low temperature folding test at -40°C)
- RoHS2 compliant. REACH compliant (SVHC free)
- Material: elastomere without halogen
- Unit test in production
- D bar code (Datamatrix) on marking with direct link to user guide and technical sheet
- Storage temperature: +10°C to +21°C
- Operating temperature: -40°C to +55°C

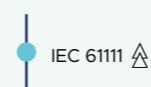

MP-11/66



MP-42/16



MP-60/05-1

Reference	Class	Voltage		Dimensions			Weight (kg)
		Operating Voltage AC	Operating Voltage DC	Length (mm)	Width (mm)	Thickness (mm)	
MP-11/66	0	1 000 V	1 500 V	600	600	2,2	1
MP-42/16	3	26 500 V	39 750 V	1 000	600	3,2	2,9
MP-60/05-1	4	36 000 V	54 000 V	1 000	600	5	4,5

One-piece insulating platform for indoor use

Application:

- Insulating platform to isolate the operator from the earth potential
- For indoor use

Features:

- One-piece moulded insulating material
- 500 mm x 500 mm non-slip top with marking area



CT-7-25/1

Insulating blanket

Application:

- Used as protection for workers operating on live parts or in the vicinity of live parts
- For live working
- Operating voltage: 1 000 V AC - 1 500 V AC

Features:

- In accordance with IEC 61112 standard class 0, and the specific properties:
- Category A: Acid resistance
- Category C: Resistance to bending at very low temperature (-40°C)
- Category H: Oil resistance
- PVC material reinforced with fibers
- Gripping tape ("Velcro®" type) all around the blanket for fixation or fitting with another blanket
- Operating temperature range: -40°C to +55°C
- High puncture resistance

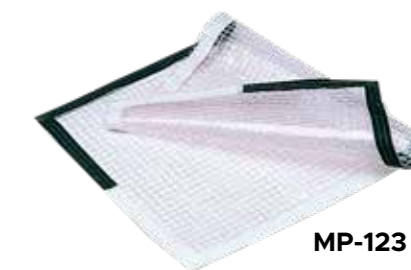

MP-123



Bi-material insulated tool kit

KIT 24

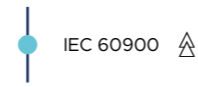

Application:

- Insulated tools for live working at low voltage

Features:

- Maximum operating voltage: 1 000 V AC - 1 500 V DC
- Soft orange dual-material thermoplastic insulation
- The insulating black material is a "SOFTGRIP" type elastomer for a better handling and a good transmission of clamping efforts
- Dielectric test on each tool after production

Composition:

- 3 flat blade screwdrivers: MO-72004 (4 x 125 mm) - MO-72006 (6 x 150 mm) - MO-72008 (8 x 175 mm)
- 2 Pozidriv screwdrivers: PZ1 MO-72042 - PZ2 MO-72044
- 1 wire stripping plier MO-72172
- 1 bent snipe nose plier MO-72142
- 1 cable cutter plier MO-72200



KIT-25

Low voltage distribution



Detex™ MS-917-L and MS-918-L voltage detectors and testers

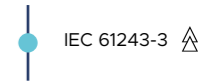

The Detex™ MS-917-L and MS-918-L are compliant with the IEC 61243-3 standard, in response to the requirements of the EN 50110-1 European standard.

Optical and acoustic signalling, suitable for indoor / outdoor use

It enables to detect presence of voltage and:

- Check voltage levels from 12 to 690 V AC, 750 V DC (MS 917-L) and from 12 to 900 V AC, 1 000 V DC (MS-918-L)
- Sound and light continuity for a dead circuit (threshold of 200 Ω for MS-917-L and 100 Ω for MS-918-L)
- Unipolar phase identification,
- Search for the polarities of a DC circuit
- Phase rotation by the two-wire method (MS-918-L)



MS-917-L | MS-918-L

Contact probes for L.V. detectors MS-8013/2 & MS-8014/2

Application:

- Contact probes to be used as round tip contact
- To be used with detectors MS-917-L, MS-918-L and MS-920-EX
- Hatch for storage of test probe
- With tip retention hatch (anti-tear system) that prevents the tip from being accidentally disconnected from the antenna
- Use at low voltage (1 000 V AC - 1 500 V DC)

Features:

- Sticks light and strong made of injection molded thermoplastic



MS-8013/2

Earthing and short-circuiting equipment for industrial LV switchboards

Application:

- Earthing and short-circuiting equipment for low voltage cabinets and industrial installations
- Short circuiting rating: 4 to 10 kA/1 s

Composition:

- 1 earthing and short-circuiting assembly with 5 branches made of copper cable with silicon insulation, cross-section 16 mm²
- Cable lengths between phases: 250 and 300 mm. Earthing cable length: 2 m
- 5 micro-clamps MC-300
- 1 plastic carrying case



Reference	Cross - section (mm ²)	Rating (kA/1 s)
MC-296-NFC-16	16	4
MC-296-NFC-25	25	7
MC-296-NFC-35	35	10

Earthing equipment for electric motors 14 kA / 1 s

Application:

- Earthing and short-circuiting equipment for industrial motors
- Unique and innovative: Finally, a solution adapted to the problems of all industrial engines
- Safety: Ensures the earthing of installations during maintenance.
- Easy and safe to use
- Universal: Suitable for most installations
- Allows working on cables with or without lugs

Features:

- Maximum short circuit rating 14 kA / 1 s
- 1 body made of copper alloy
- Connection points for earthing and short-circuiting cables equipped with lug terminals and fixing hole greater than 8 mm
- Connection points for earthing and short-circuiting cables with bare ends and maximum diameter 8 mm
- 1 earthing cable made of copper with extra flexible PVC insulation, cross-section 50 mm², length 2 m
- 1 earthing clamp MT-840/1
- 1 protection bag

MC-281/1



MC-281/1



Waterproof protection cover



Find out more on our product range at www.catuelec.com



Medium voltage substation

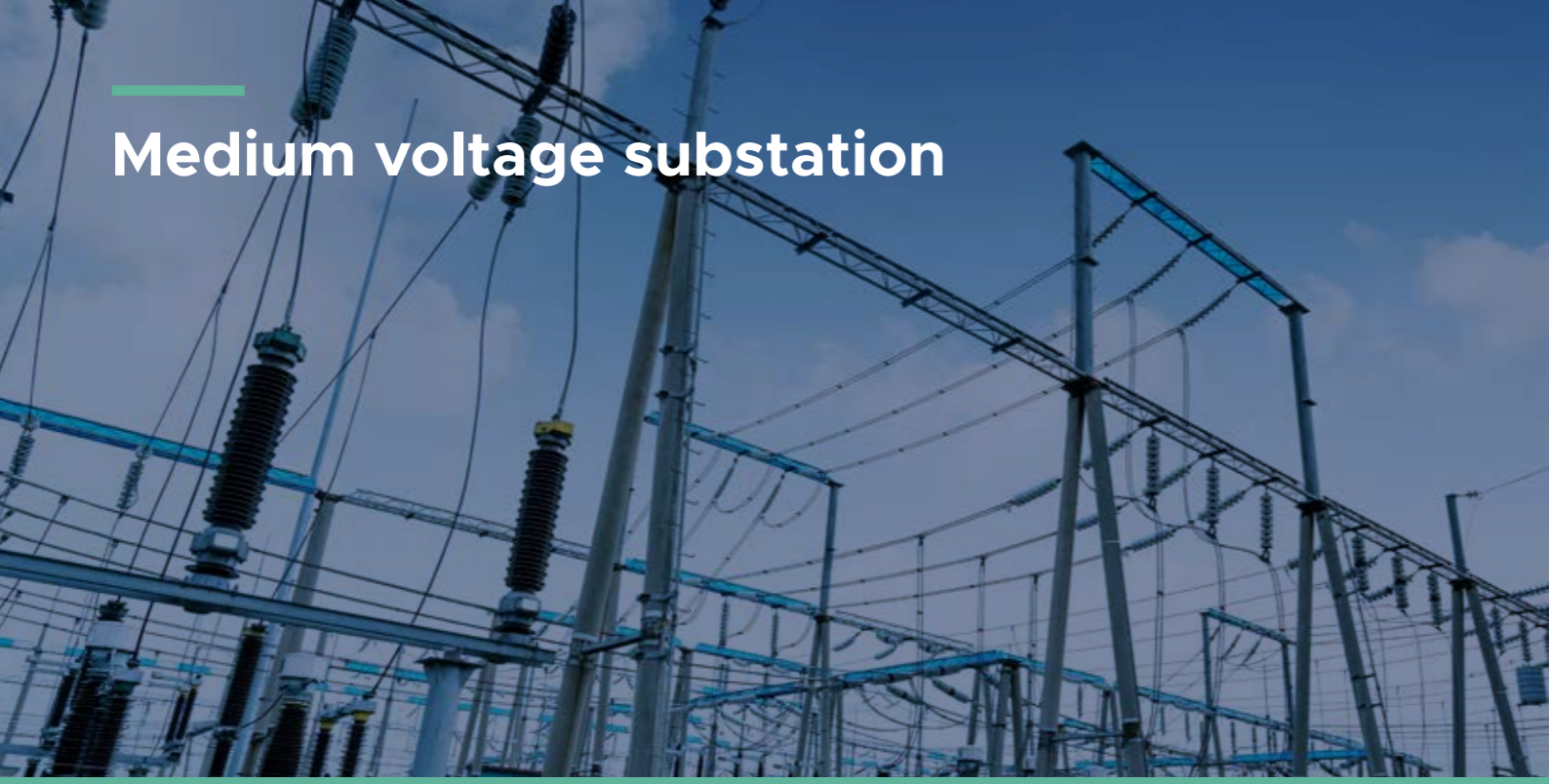

Voltage detector for MV substation CL-465

Application:

- Optical absence of voltage detector for MV substation with integrated insulating pole
- Maximum operating voltage: 36 kV

Features:

- Built-in function control device (auto-test)
- Robust molded thermoplastic housing providing excellent impact protection
- Interchangeable V-shaped contact electrodes
- 360° visual indication by means of a high visibility red LED
- Lithium battery with 8 years autonomy in standard use

Composition:

- Supplied in vinyl bag with wall brackets CI-06-D

CL-465-10/30-M

Reference				
	Voltage	Folded up (m) Length	(m) Length	
CL-465-10/30-M*	10-30 kV	-	1.35	1
CL-465-10/36-M*	10-36 kV	-	1.35	1
CL-465-10/30-2**	10-30 kV	0.75	1.18	0.9
CL-465-10/36-2**	10-36 kV	0.75	1.18	0.9

*Fixed pole **Telescopic pole



Voltage detector on capacitive bushings CC-162-K

Application:

- Unipolar voltage detector for elbow connectors with capacitive divider
- Maximum operating voltage: 36 kV network

Features:

- Voltage range: 3 to 36 kV
- The shape of the contact electrode facilitates the cap removal from the separable connector
- Signalization:
 - 1 red LED (voltage presence);
 - 1 green LED (standby state);
 - Timed audio signal
- Function check by pressing the TEST button:
 - Switch on by flashing red LED
 - Triggering of the clocked sound signal
- Fixing on insulating stick by universal notched tip type "K"

Composition:

- Supplied in a hard case

Optional accessories:

- Insulating stick: MT-830-PK, CC-45-K
- Stick bag: CM-1-10

Telescopic insulating stick

Application:

- Earthing and short-circuiting and Voltage detection
- Disconnecting/reconnecting
- Indoor/outdoor

Features:

- Locking by push button in folded and extended positions
- 0,64 m folded - 1,5 m deployed
- 3 sections
- Insulating level: 45 kV

Reference	End-fitting
MT-830-P	Type C (hexagonal 12mm)
MT-830-PK	Type K (universal)
MT-830-PE	Type E (bayonet)

CC-162-K

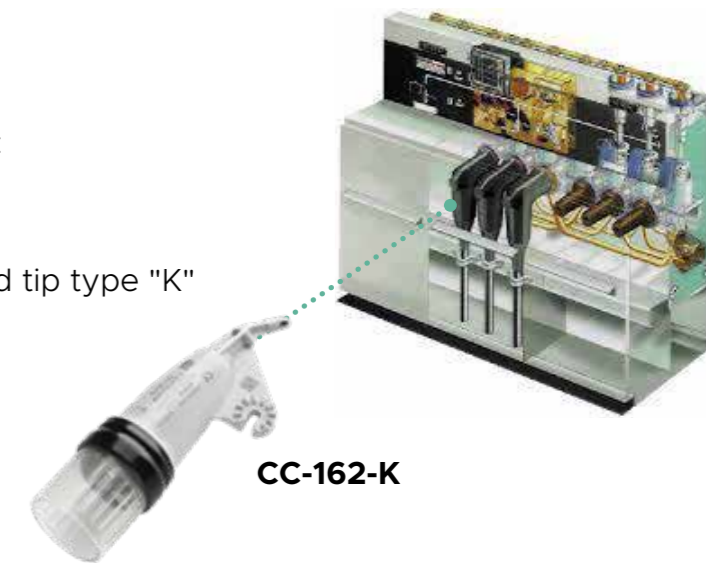

MT-830-PK



Earthing and short-circuiting Equipment MT-5805-P

Application:

- Portable equipment for overhead networks
- Rating: 20 kA/1 s

Features:

- MT-815-C conductor clamp with 12 mm type C hexagonal tip across the flats
- Clamp capacity: round from 5 to 35 mm and flat from 5 to 40 mm
- Plastic carrying case

Composition:

- 3 conductor clamps MT-815-C
- 1 earth clamp MT-840/1
- 1 set of 3 short-circuit cables, 70 mm² long section, 1.5 m extra flexible copper cable with transparent insulating sheath
- 1 cable, 35 mm², 2.5 m long, extra flexible copper cable with transparent insulating sheath

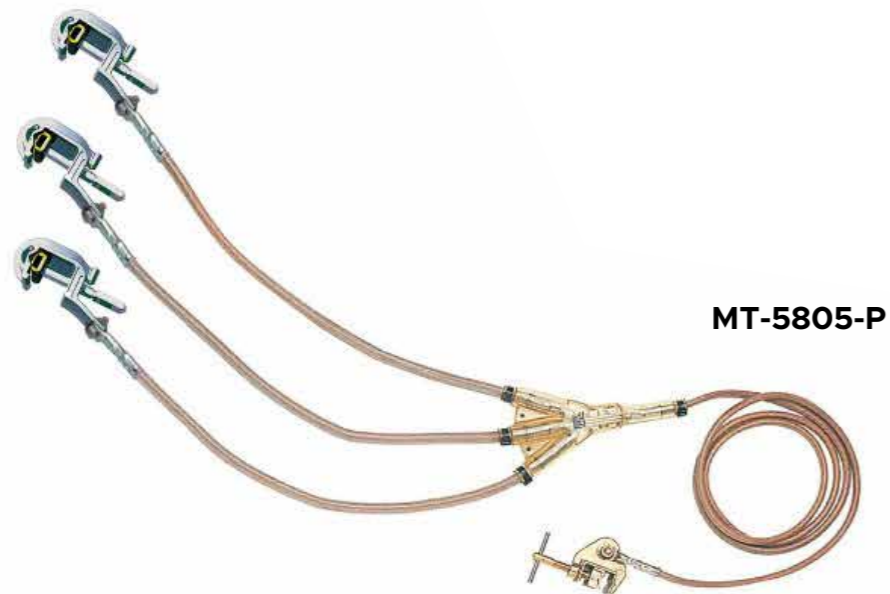

MT-5805-P

Reference	Rating (kA/1 s)	Composition	Connection set	Capacity (mm)	Weight (kg)
MT-5805P	20	3xMT-815-C 1xMT-840/1	3 cables 70 mm ² 1 earth cable 35mm ²	Ø5-35 16-40 5-40	8

Recommended insulating stick: MT-830-P

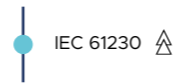

Life saving kit for substation CZ-55

Application:

- Allows an intervention on victims in case of electrical shock
- Immediately makes available to rescuers all the necessary rescue equipment

Features:

- Kit delivered with a transparent cabinet to be mounted in the substation (supplied with wall mounting accessories)

Composition:

- 1 insulated cable cutter CZ-60
- 1 telescopic rescue stick extended length 1.65 m M-952160
- 1 voltage detector with flexible contact antenna and equipped with a metal rescue hook (3 kV - 40 kV) M-952170
- 1 pair of insulating gloves class 3 CG-3-10-NR (CZ-54 models), CG-4-10-NR (CZ-55 models)
- 1 pair of insulating boots MV-135-45 (CZ-54 & CZ-55), over boots class 3 MV-139-L (CZ-54-FM & CZ-55-FM)
- 1 insulating platform
- 1 "First aid for electric shock victims" poster in french on the cabinet door



CZ-54

Reference	Characteristics	Installation Voltage (kV)	Dimension (mm)	Weight (kg)
CZ-54	English instructions	24	840 x 754 x 270	21
CZ-54-FM	English/Arabic instructions	24	840 x 754 x 270	21
CZ-55	English instructions	36	840 x 754 x 270	21
CZ-55-FM	English/Arabic instructions	36	840 x 754 x 270	21

Medium voltage & high voltage overhead line and substation

Electronic voltage detector (MV) CC-765

Application:

- Electronic voltage detector for indoor and outdoor use, with high level of shock, vibration and rain resistance
- Capacitive head technology, ultra compact
- Broad voltage range, operating frequency 50 and 60 Hz

Features:

- Robust thermoplastic housing
- Voltage presence signaled by:
 - Flashing red LEDs;
 - Powerful audible signal (67 dB (A)/1.5 m);
- Visible over 360° with lighting and display
- Contact electrodes easily interchangeable

Composition:

- Supplied with an end-fitting matching the insulating stick terminal:
 - C: hexagonal 12 mm
 - K: universal
 - U: UDI end-fitting with a U shape (55 mm overhang) for sticks with UDI end-fitting.
- CC-765-44/132 & 63/90 versions are supplied with 1 hook-shaped contact electrode Ø 120 mm, Ref. CC-ANT120
- Supplied in a carrying case

Optional accessories:

- Recommended insulating sticks: MT-830-.. (page 59) or CE-2-.. (page 64) or CE-5-.. (page 63)



CC-765

Reference	Frequency	Operating Voltage	Type 6 LR 61	Weight (kg)
CC-765-2/7,2-(*)	50/60 Hz	2-7.2 kV	9 V	0.35
CC-765-3/10-(*)	50/60 Hz	3-10 kV	9 V	0.35
CC-765-5/18-(*)	50/60 Hz	5-18 kV	9 V	0.35
CC-765-5.5/20-(*)	50/60 Hz	5.5-20 kV	9 V	0.35
CC-765-10/36-(*)	50/60 Hz	10-36 kV	9 V	0.35
CC-765-15/45-(*)	50/60 Hz	15-45 kV	9 V	0.35
CC-765-20/66-(*)	50/60 Hz	20-66 kV	9 V	0.35
CC-765-44/132-(*) ⁽¹⁾	50/60 Hz	44-132 kV	9 V	0.35
CC-765-63/90-(*) ⁽¹⁾	50/60 Hz	63-90 kV	9 V	0.35

(*) C or K or U

Telescopic insulating stick

Application: CE-5

- Voltage detection
- Disconnecting/reconnecting
- Outdoor

Features:

- Material: insulating tube made of epoxy resin, glass fiber reinforced
- Locking of each section by push button, in folded and extended positions
- Compliant to IEC 61235, IEC 62193 §6.4.2
- Extended length range: 5 - 10,75 m

Reference	Length folded (m)	Length unfolded (m)	Weight (kg)	Number of sections	U max use (kV)
CE-5-105-X	1,66	10,75	5,4	8	970
CE-5-90-X	1,61	9,25	4,2	7	830
CE-5-70-X	1,56	7,8	3,3	6	690
CE-5-60-X	1,51	6,4	2,5	5	550
CE-5-50-X	1,46	5	1,9	4	420

CE-5

Electronic voltage detector (HV) CC-265

Application:

- Electronic voltage detector for outdoor use with high resistance to shock, vibration and rain
- Capacitive head technology, ultra compact
- Operating voltage: according from 44 up to 420 kV

Features:

- Housing / electronic circuit design with quick release for easy battery replacement
- Double signaling with presence of voltage indicated at the same time by:
 - Bright red flashing light-emitting diodes (visible at more than 50 meters even in direct lighting)
 - Strong nominal acoustic signal (67 dB (A)/1,5 m)
 - 360° vision with illuminated display for optimum visibility
- Interchangeable contact electrodes

Composition:

- Supplied with 3 end fittings for stick mounting:
 - W: hexagonal 20 mm across the flats
 - C: hexagonal 12 mm across the flats
 - K: universal
- Supplied with a shock-proof case with handle

Optional accessories:

- Hook type contact electrode diam. 60 mm. Reference: **CC-ANT601**
- Hook type contact electrode diam. 120 mm. Reference: **CC-ANT1201**
- Hook type contact electrode diam. 200 mm. Reference: **CC-ANT2001**
- Recommended insulating sticks: **MT-830-.. or CE-2-.. or CE-5-..**

Reference	Voltage range	Housing color	Contact electrode included
CC-265-44/132	44-132 kV	Red	CC-ANT1201
CC-265-60/90	60-90 kV	Yellow	CC-ANT1201 & CC-ANT601
CC-265-60/150	60-150 kV	Red	CC-ANT1201 & CC-ANT601
CC-265-90/225	90-225 kV	Red	CC-ANT1201
CC-265-90/245	90-245 kV	Red	CC-ANT1201
CC-265-120/245	120-245 kV	Red	CC-ANT2001
CC-265-225/420	225-420 kV	Red	CC-ANT2001 & CC-ANT1201 & CC-ANT601



CC-265

Earthing and short-circuiting equipment for overhead networks, rating 8 kA/1 s MT-6613

Application:

- Earthing equipment for overhead networks
- Installation by insulating pole and dispenser
- Rating 8 kA/1 s

Features:

- 3 MT-613 clamps with pre-arming. Capacity: round from 5 to 30 mm
- 2 short-circuit cables length 2.75 m, section 35 mm² between 2 clamps
- 1 earth cable length 16 m, section 16 mm²
- 1 carrying bag

MT-6613



IEC 61230

Telescopic insulating stick CE-2-X

Application:

- Voltage detection
- Earthing and short-circuiting
- Disconnecting/reconnecting
- Indoor/outdoor

Insulation nominal voltage:

- CE-2-15/1-(*) = 66kV 1,5m
 - CE-2-21/1-(*) = 90kV 2m
 - CE-2-25/1-(*) = 132kV 2,5m
- Insulating test IEC 62193:2003, 6.4.2:
100 kV / 300 mm / 1 min

Features:

- Material: insulating tube made of epoxy resin, glass fiber reinforced
- Locking by push button in folded and extended positions
- Unfolding and folding made easier thanks to indicative arrows on each tube

(*) C: hexagonal end-fitting, 12 mm across the flat
E: bayonet end-fitting
K: universal end-fitting

CE-2-21/1-C



Earthing and short-circuiting clamps for busbars and line conductors

Range

Reference	Clamping range Ø (mm)	Short circuit rating (kA/1 s)	Short circuit rating (kA/5 s)	Weight (kg)
MT-736-065-(*)	4-65	40	34	1.15
MT-736-085-(*)	20-85	40	34	1.3
MT-736-150-(*)	40-150	40	34	2.1
MT-736-225-(*)	110-225	40	34	2.5



IEC 61230

(*) E: bayonet end-fitting H: hexagonal end-fitting, 26 mm across the flat

Raccordable insulating stick

Application:

- Base element to be combined with the elements of the CM-46.. series (Terminals and Intermediates)
- Connectable by an insulated self-locking system made of aluminium alloy
- Voltage detection
- Earthing and short-circuiting
- Disconnecting/reconnecting
- Indoor/outdoor (under wet conditions)

Features:

- Material: insulating foam-filled tube made of epoxy resin, glass fiber reinforced
- Fitted with grip, a handguard and an anti-shock bottom cap with a manoeuvring loop

IEC 60855
IEC 50508

CM-46



Sticks in separate elements:

Basic element			
Reference	Length (m)	Weight (kg)	Insulating length / nominal voltage (kv)
CM-4610	1	1,35	0,08 / Δ
CM-4615	1,5	1,8	0,33 / Δ
CM-4620	2	2,8	0,33 / Δ
CM-4625	2,5	3,3	0,83 / Δ
Intermediate element			
Reference	Length (m)	Weight (kg)	Insulating length / nominal voltage (kv)
CM-4610 - I	1	1,3	0,8 / Δ
CM-4615 - I	1,5	1,7	1,3 / Δ
CM-4620 - I	2	2,6	1,8 / Δ
CM-4625 - I	2,5	3,1	2,3 / Δ
Final element			
Reference	Length (m)	Weight (kg)	Insulating length / nominal voltage (kv)
CM-4610 - *	1	1	0,8 / Δ
CM-4615 - *	1,5	1,4	1,3 / Δ
CM-4620 - *	2	2,2	1,8 / Δ
CM-4625 - *	2,5	2,7	2,3 / Δ

(*) end fitting: C: hexagonal 12 mm across the flats | E: bayonet | H: hexagonal 26 mm across the flats | K: universal

Pole adaptors fitting

Product Code	Dimensions (mm)	Weight (kg)	Use
CI-6-H	230 x Ø 40	0,300	Indoor/Outdoor
CI-7-E	260 x Ø 45	0,035	Indoor/Outdoor

Vinyl sheathed copper cable for earthing devices

Application:

- Earthing and short-circuiting cables

Features:

- Material: Extra flexible copper cable with insulating transparent sheath (PVC)
- Minimum bending radius: 4 times the cable diameter
- Operating temperatures: -40°C to +60°C
- Standard marking every 500 mm
- Delivered by 5 m minimum



SCC

Reference	Section (mm ²)	kA/1s
M-24-16	16	4.5
M-24-25	25	7
M-24-35	35	10
M-24-50	50	14
M-24-70	70	20
M-24-95	95	27
M-24-120	120	34
M-24-150	150	42.5

Couple of copper tubular lugs

Reference	Cross-section (mm ²)
MCC16	16
MCC25	25
MCC35	35
MCC50	50
MCC70	70
MCC95	95
MCC120	120
MCC150	150



Assembling reference : FMDIRECT
 Marking reference : FMMARQ 16/70/95

Earth clamps

Application:

- Earthing clamp

Features:

- Material: Copper aluminium

Reference	Rating kA/1 s	Dimensions (mm)	Connection (mm)	Clamping capacity	Weight (kg)
MT-840/1	20	40 x 73 x 135	Thread: Ø 12.5mm	Ø 6-25 0-25	380
MT-841	30	40 x 73 x 135	Connect Fontenay ≤ 50mm ²	Ø 6-25 0-30	380
MT-843	40	45 x 106 x 165	Hole: Ø 12.5mm	Ø 6-25 0-35	0.95



Custom prefabricated modular manufacturer

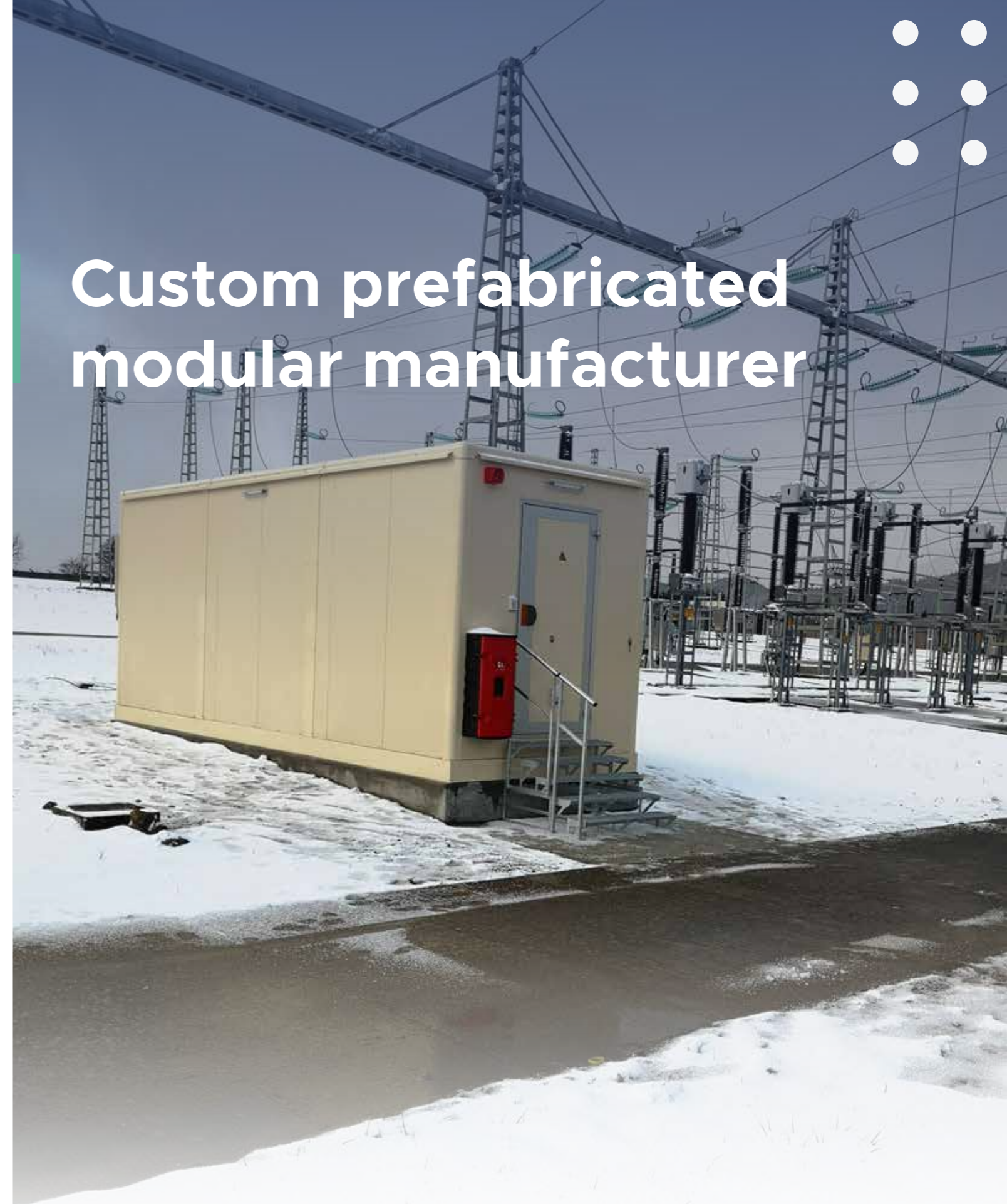

Seifel is expert, for 40 years, in the telecom shelters & railway expanded its offer to develop its expertise in IT

In recent years, the speed of digitalization and the constant growth in demand for computer data processing have impacted the data center industry. Local data centers are essential to provide this digital transformation and ensure data sustainability. One of the answers to this development is the big development of prefabricated modular data center as an alternative for IT data center operators or manufacturers.

Definition of the modular data center

Prefabricated, fully enclosed mobile structure housing data center infrastructure. Infrastructure segmented into 3 categories: Power, Cooling, IT.

Why a prefabricated modular data center

- Very fast deployment – pré-qualification of shelter and factory tests – Less subcontracting on construction sites
- Design flexibility – Much possibility of integration in the environment
- Overall cost – <15% - Product and Installation
- Industrial design with integrated engineering office specialized in IT, cooling, mechanics and energy
- Integrated solution plug & play, sobriety and security
- Unlimited scalability and self-stability

Related services

- Data design assistance: Energy calculation note in compliance with NFC15100
- Thermal balance for the dimensioning of the cooling / freecooling
- Initial electrical check
- Transport and unloading on site by a dedicated team of experts
- Project management, dimensioning of data center supports (concrete blocks or concrete slabs, etc.)
- On-site commissioning: user training with USB media

Prefabricated modular data center typology

- Several possible envelope materials:
- Metal & aluminum light shelter
- Modified container shelter
- Heavy concrete shelter
- Thermoplastic shelter
- Mixed shelter

IT

- Rack 42U to 47U – 600x600mm to 800x1200mm
- PDU intelligent
- Distribution bar sheath

Energy

- Custom made TGBT double & triple sources
- High performance UPS >96% efficiency - on-line double conversion - Plug & Play
- Multi-way distribution

Thermal

- Hybrid freecooling solution with variable flow
- Hot/Cold Aisle solution
- Precision air conditioning
- Security by redundancy

Security

- Door secured by CR3 lock
- Fire detection, fire suppression
- Access control, remote monitoring, intrusion

Environmental integration

- Available in RAL colour scheme
- Customization possible by stickers
- Wood cladding all wood species
- Traditional roofs



Big data



Mini data

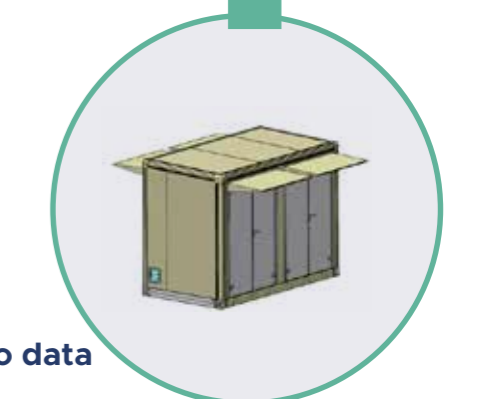

Micro data

Services

Laboratory

Tensile test

Checks and verifications on crimped samples:

- Visual inspection of the crimps
- Pull-out tests
- A tensile test report will be delivered

Macrographic section

Sections and checks on crimped samples:

- Visual inspection of the crimps according to RCCE-E4000
- Filling coefficient according to RCCE-E4000
- A report will be delivered

Control and maintenance service

We perform controls, maintenance, calibration and testing for certifications on tools, equipment, materials and PPEs, in our certified service centers or on customer site

Safety

- Single and bipolar HV/LV AC equipment
- Bipolar HV/LV AD/DC equipment
- Insulating safety gloves
- Sticks
- Grounding and short-circuiting equipment

Tools

- Control and maintenance of tools
- Cable cutters
- Shears and tools
- Cable preparation tools for LV equipment



Training

Thanks to our Sicame academy we are able to offer a large panel of trainings Consult us for further information. <https://www.sicame-academy.com/>

- HV-LV overhead and underground networks
- Aerial networks telecom
- Industrial connections
- Electrical general knowledge
- Low voltage live working
- Electrical habilitations NF C18-510
- Prevention and safety against electrical hazard

Site audit and investigation tests

Consult us for further information

sicame | ACADEMY





Sicame Group

+33 (0)5 55 73 89 00
1 boulevard Marius Vivier Merle, 69003 Lyon, France

 sicame-group.com